

Streetlight Master Plan 2023



Prepared By:

Micah Bandurraga, Transportation and Utility Coordinator
Warren Stewart, City Engineer
Laurelei McVey, Public Works Director

Table of Contents

Executive Summary.....	4
Ensuring and Enhancing Public Safety	6
Existing Conditions.....	8
System Inventory Statistics (May 1, 2023).....	8
HPS and Underserved Area Lights By Council District	8
Program History	8
5-Year Program Plan (2024-2028).....	10
Capital Improvement Plan (CIP)- 2024-2033	11
FY2024 CIP	13
FY2025 CIP	17
FY2026 CIP	19
FY2027 CIP	22
FY2028 CIP	25
FY2029 CIP	27
FY2030-FY2033.....	29
CBDG Priority Plan (FY24-FY33)	30
PW Budget Recommendation.....	31
Underserved Areas Plan.....	32
Underserved Areas (Needed Lighting Additions)	32
How Underserved Area Install Priorities Are Determined.....	34
Underserved Area Funding	34
Underserved Area Progress	35
Future Funding Needs.....	36
Planned Funding (FY2023-FY2033)	36
LED Conversion Plan	37
HPS to LED Conversion Program.....	37
LED Upgrade Progress.....	38
Annual Savings Calculations - Power and Maintenance	38
Funding Needed	39
Planned Funding (FY2023-FY2033):	40
Alternatives Analysis.....	40
Return on Investment.....	40

Streetlight Program Constraints 42

Appendix A – Streetlight Characteristics/Considerations/Types 48

Appendix B – New Streetlight Installation Process 57

New Installation Process 57

Warranty Process 58

Future Install Agreements 58

Reimbursement Agreements 58

Appendix C – City of Meridian Street Lighting Specifications 59

Appendix D – City of Meridian Street Lighting Design Standards 67

Appendix E – Future Install/Reimbursement Agreement 84

Appendix F – Streetlight Underserved Areas 89

Appendix G – Customer Service and Customer Complaints Process 93

Outage Procedures/Complaint Processes 93

Outages/Customer Calls/Complaints 93

Damage Claim Process 94

Shielding 94

Appendix H – Annual Report Information 96

Executive Summary

The 2023 Streetlight Master Plan, which is the first ever conducted by the City, aims to document existing program conditions, review program goals, discuss program constraints, and establish a 5-year program and capital improvement plan.

The Streetlight Program has five fundamental objectives:

1. Ensuring and enhancing public safety
2. Reviewing and integrating new streetlights into the system
3. Ongoing operational activities (maintenance, repairs, and customer service)
4. Adding new streetlights to underserved areas
5. Converting high pressure sodium (HPS) lights to LED lights

Streetlights are an essential component of public safety infrastructure. By providing illumination and increasing visibility, they can help to reduce accidents, deter crime, and create a safer environment for all members of the community.

Most new streetlights that are added to the City's system are installed and paid for by developers or ACHD/ITD. Once these lights are integrated into the system, the City is responsible for paying for ongoing power, maintenance, and repairs.

The City has several areas that were built before uniform streetlighting standards were developed and implemented in the City. As such, there are parts of the City that potentially have too few streetlights to meet current City lighting standards and objectives. The City funds the installation of these additional streetlights through both the City's general fund and Community Development Block Grants (CDBG). At the current level of general fund funding (~\$85K/year), it will take more than 100 years to complete lighting installation at all remaining underserved areas. CDBG funding is not guaranteed and the amount distributed varies annually. Using the historic annual average amount received for streetlighting (~\$89K/year), all CDBG eligible lighting areas would be complete in approximately 37 years.

Converting all remaining City owned HPS lights (56% of the system) to LED has ongoing operational savings in both power and maintenance costs of at least \$159K per year. At the current level of funding (~\$100K/year), it will take approximately 20 years to convert the remaining 4,800 lights. However, if the City desires to greatly accelerate the conversion of these lights, additional budget and staffing or consultant resources will be needed. Accelerating LED conversions would allow the City to realize savings sooner but also adds additional costs (staffing or consultant costs) to the return on investment calculations. An optimized scenario could include increasing the funding for the LED conversion program to \$260K annually. This is likely the maximum annual conversions that could be accomplished without adding additional labor resources. Funding at this level would allow the conversions to be completed in approximately 8 years with a calculated 20-year savings of nearly \$1M.

The City's Streetlight Program does have several program constraints that impact both levels of service and program goals and are discussed in more detail throughout the Streetlight Master Plan. The most significant constraints include data accuracy, rising material/labor costs, staffing levels, and long-term

program funding. The Public Works Department is currently working on migrating all streetlight data tracking into its existing asset management software platform (Infor Public Sector- IPS) to organize, standardize, and optimize program management. Additionally, with approximately 300-500 new streetlights added to the City each year, primarily through development driven growth, the Streetlight Program has grown by 155% since 2010 when the Public Works Department took over program management. Today, the Public Works Department's Transportation and Utilities Coordinator continues to be the single staffing resource dedicated to this program.

The Streetlight Master Plan outlines several important goals for the next five-year period which will help evaluate, improve, and work to address existing program constraints.

A detailed 5-year capital improvement plans for both LED upgrades and new lighting installs in underserved areas can be found in the capital improvement plan section of this plan.

Ensuring and Enhancing Public Safety

The overarching goal of the Meridian Streetlight Program is to ensure and enhance public safety throughout the City. Streetlights play a crucial role in enhancing public safety in several ways.

Improved visibility: Streetlights provide illumination to roads and sidewalks, making it easier for drivers, pedestrians, and cyclists to see their surroundings. This increased visibility reduces the likelihood and severity of accidents and makes it easier for people to navigate the streets at night.

Deter crime: Well-lit areas can deter criminal activity by making it easier for people to see and identify potential criminals. Criminals are less likely to target well-lit areas, as they are more likely to be seen and caught.

Increased sense of security: Adequate lighting can help people feel safer and more secure while walking or driving at night. This sense of security can encourage more people to use public spaces, increasing foot traffic and creating a more vibrant community.

Emergency response: Streetlights provide better visibility for emergency responders, making it easier for them to navigate and find their way to a location increasing response times.

Additionally, numerous studies support the effectiveness of streetlighting in reducing fatalities and crime rates in communities. The American Association of State Highway and Transportation Officials (AASHTO) found that streetlighting reduced the nighttime crash rates by 30%. Importantly, according to studies completed by the Federal Highway Administration, the nighttime fatality rate of crashes is three times the daytime rate. Installing and maintaining streetlighting can help a community reduce the number and severity of crashes.

The Urban Labs Study (University of Chicago) also “found that the developments that received new lights experienced crime rates that were significantly lower than would have been the case without the new lights. Among other findings, the study concluded that increased levels of lighting led to a 36% reduction in "index crimes" — a subset of serious felony crimes that includes murder, robbery and aggravated assault, as well as certain property crimes.”

The following maps indicate the 2021-2022 Dusk to Dawn reported crimes in the City of Meridian overlaid on top of current areas with streetlighting that does not meet current City lighting standards (underserved areas). While there are many factors that contribute to crime rates in an area, streetlights can serve as an additional deterrent to some crimes and help to improve overall public safety.

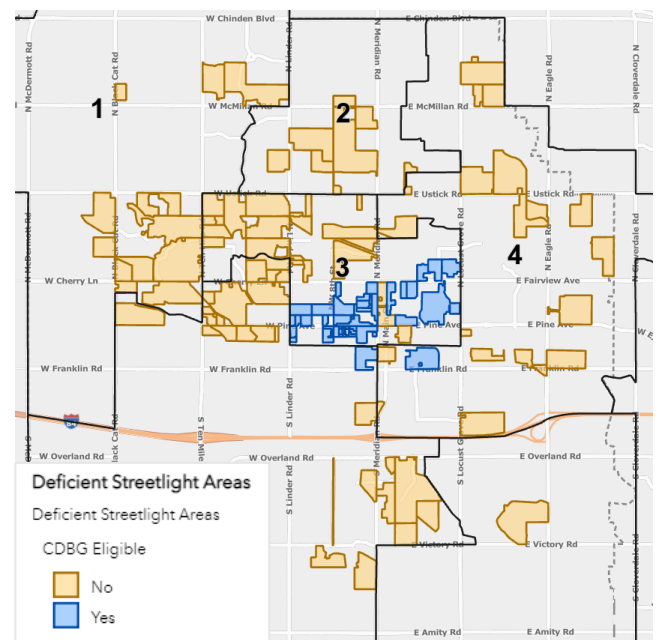

STREETLIGHT MASTER PLAN

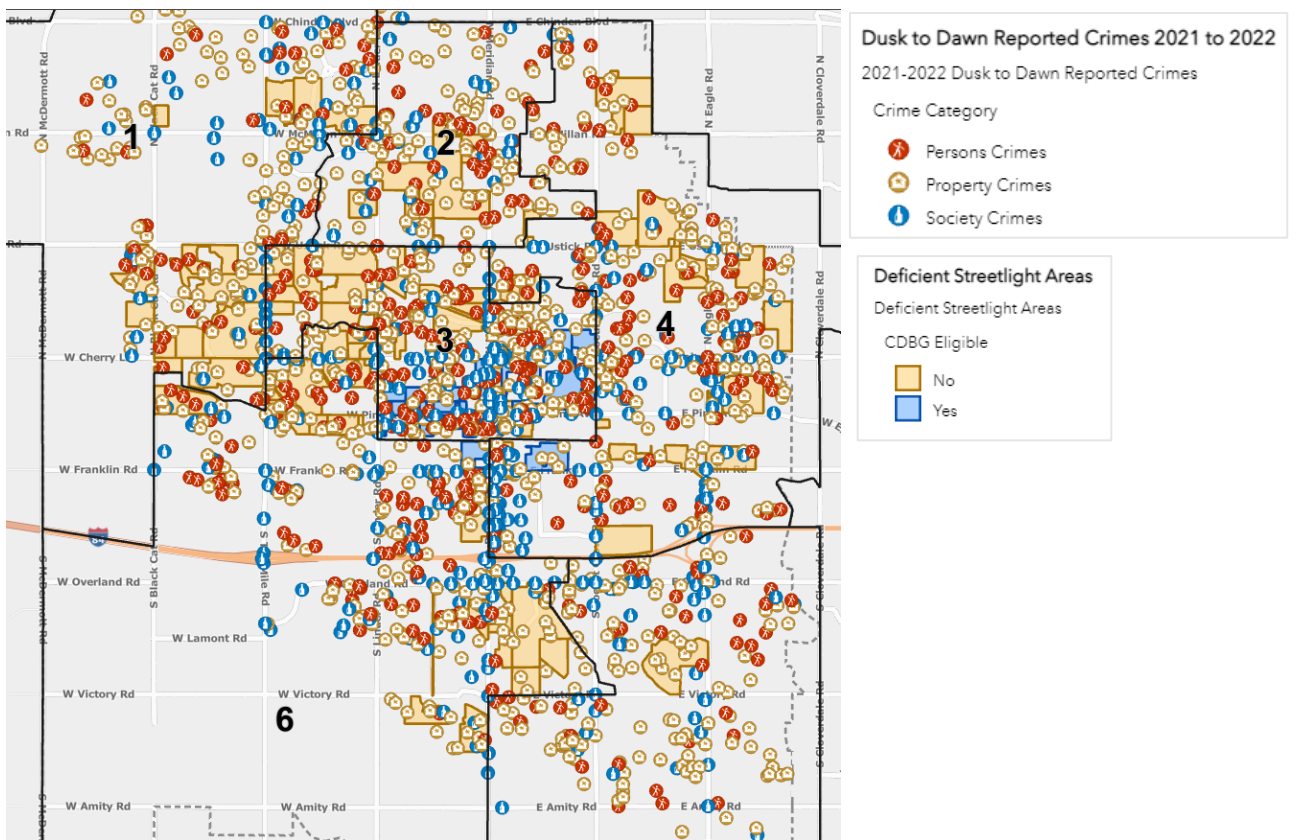
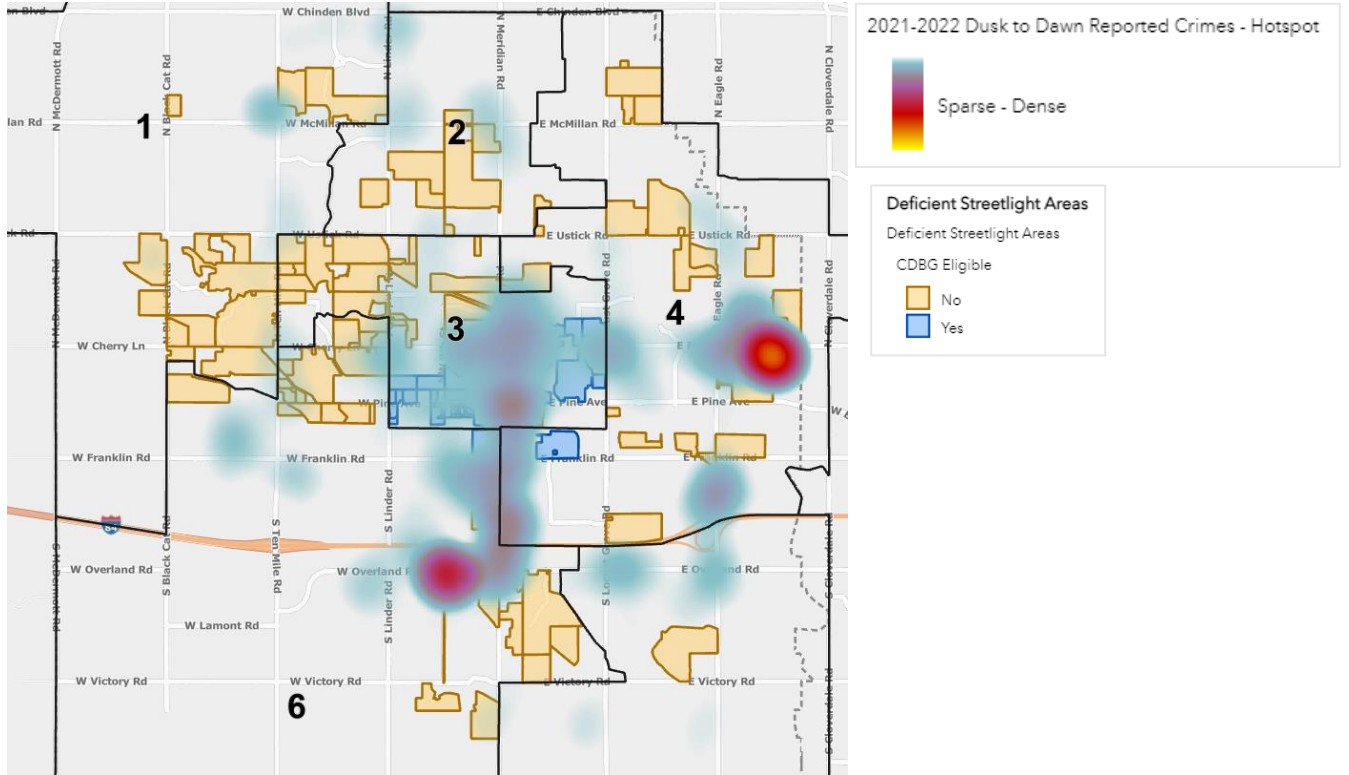

Existing Conditions

System Inventory Statistics (May 1, 2023)

*NOTE: Some data inaccuracies exist in the City's streetlight tracking database/GIS. As such, some numbers throughout the report are estimates. Cleaning up and integrating this data into the City's asset management system is a planned program goal.

- 8,595 Total Streetlights
 - 8,145 City Owned Streetlights
 - 358 Idaho Power Owned Streetlights (City pays the power bill)
 - 92 Private HOA Lights where the City pays the power bill

- LED vs HPS
 - 4,448 Light Emitting Diode (LED) lights (44%)
 - 4,827 High Pressure Sodium (HPS) lights (56%)

- Approximately 300-500 new LED lights are installed per year through various sources:
 - Development projects
 - City capital projects
 - Ada County Highway District (ACHD) projects
 - Idaho Transportation Department (ITD) projects

- Underserved Areas Lights Identified
 - ~1,680 additional lights are needed

- Full City Buildout (~2074)
 - Will have ~29,000 streetlights

HPS and Underserved Area Lights By Council District

District	HPS Remaining	New Lights Needed (Underserved Areas)
1	826	317
2	944	64
3	881	697
4	783	247
5	685	30
6	708	324

Program History

Prior to 2003, Idaho Power created a basic streetlight program as a public service for improved safety. Idaho Power meant for the program to be a temporary bridge until cities could develop their own self-sustaining streetlight programs. The Idaho Power Streetlight Program was limited in the amount of

resources and never installed enough streetlights to be a sufficient streetlight program for the City long term.

In 2003, the City of Meridian began paying Idaho Power for the power use on the Idaho Power owned streetlights. Today, there are still currently 358 of these lights in the system (~4% of City owned system). However, as the City continues developing streetlight upgrades, these Idaho Power owned light fixtures often become redundant and are removed because they do not meet City lighting standards and are usually non-LED.

In 2010, the City's Public Works Department took over managing the City's Streetlight Program and implemented streetlighting standards that conformed with the American Association of State Highway and Transportation Officials (AASHTO) and Illuminating Engineering Society (IES) to establish a uniform direction for future streetlight design and development.

As of 2016, all new streetlights installed in the City were required to be LED.

Today's Streetlight Program contains four major elements that Public Works manages:

- Installation and tracking of new lights installed by the City and developers
- Conversion of HPS to LED
- Adding lights to underserved areas
- Maintenance, repairs, and outages of existing lights

5-Year Program Plan (2024-2028)

- Execute the Annual Capital Improvement Plan
- Improve Data Accuracy
 - Clean up GIS database to be accurate and complete
 - Integrate streetlights into the City's asset management database structure (IPS)
 - QC all streetlights in the system via PW Staff/Internship program
 - Improve system longevity through an asset management maintenance program
 - Evaluate streetlight GPS process
 - Identify the locations of co-located utilities
 - Identify direct bury poles
- Maintenance Program Improvements
 - Streamline processes to improve efficiency and maintenance timelines
 - Develop and implement a maintenance/repair roster
 - Evaluate options for City discontinuing paying for power for HOA/private street lighting (design standard 6-9.1.1)
- Evaluate Staffing Resources
 - Evaluate the need for a Streetlight Program Coordinator position
 - Evaluate return on investment for an in-house maintenance position
- LED Conversion Program
 - Evaluate increasing the number of LED upgrades per year
- Investigate New Technologies

Capital Improvement Plan (CIP)- 2024-2033

The following maps detail the proposed 5-year capital improvement plan for both LED upgrades and new lights in underserved areas.

The following Capital Improvement Plans assume the funding levels that are currently listed in the City's CFP (Comprehensive Financial Plan). Because CDBG funds are not guaranteed and are variable in the amounts received annually, a detailed capital plan has not been developed. However, CDBG eligible areas have been prioritized and will be addressed as funding is received. A summary of the projected 5-year CDBG projects is included at the end of this section.

Fiscal Year	Current CFP Funding (LED)	Estimated LED Lights Completed	Current CFP Funding (Underserved Areas)*	Estimated New Lights in Underserved Areas
FY2024	\$164,000**	182	\$79,750	8
FY2025	\$100,000	186	\$84,750	9
FY2026	\$100,000	190	\$84,750	9
FY2027	\$100,000	190	\$84,750	6
FY2028	\$100,000	193	\$84,750	9
FY2029	\$100,000	192	\$84,750	9
FY2030	\$100,000	192	\$84,750	9
FY2031	\$100,000	192	\$84,750	9
FY2032	\$100,000	192	\$84,750	9
FY2033	\$100,000	192	\$84,750	9
10 Year Totals	\$1,064,000	1,901	\$842,500	86

*Note: \$45,000 (FY2024) and \$50,000 (per year FY2025-FY2033) are shown in the CFP database. The remaining funding comes from the annual streetlighting base budget funding (\$34,750).

**Note: Increase from standard amount to address intersection HPS conversion recommendation from the Meridian Intersection Pedestrian Safety Task Force.

STREETLIGHT MASTER PLAN

Planned FY	Planned LED Upgrade	Planned New Lights in Underserved Areas
FY24	★	●
FY25	★	●
FY26	★	●
FY27	★	●
FY28	★	●
FY29	★	●

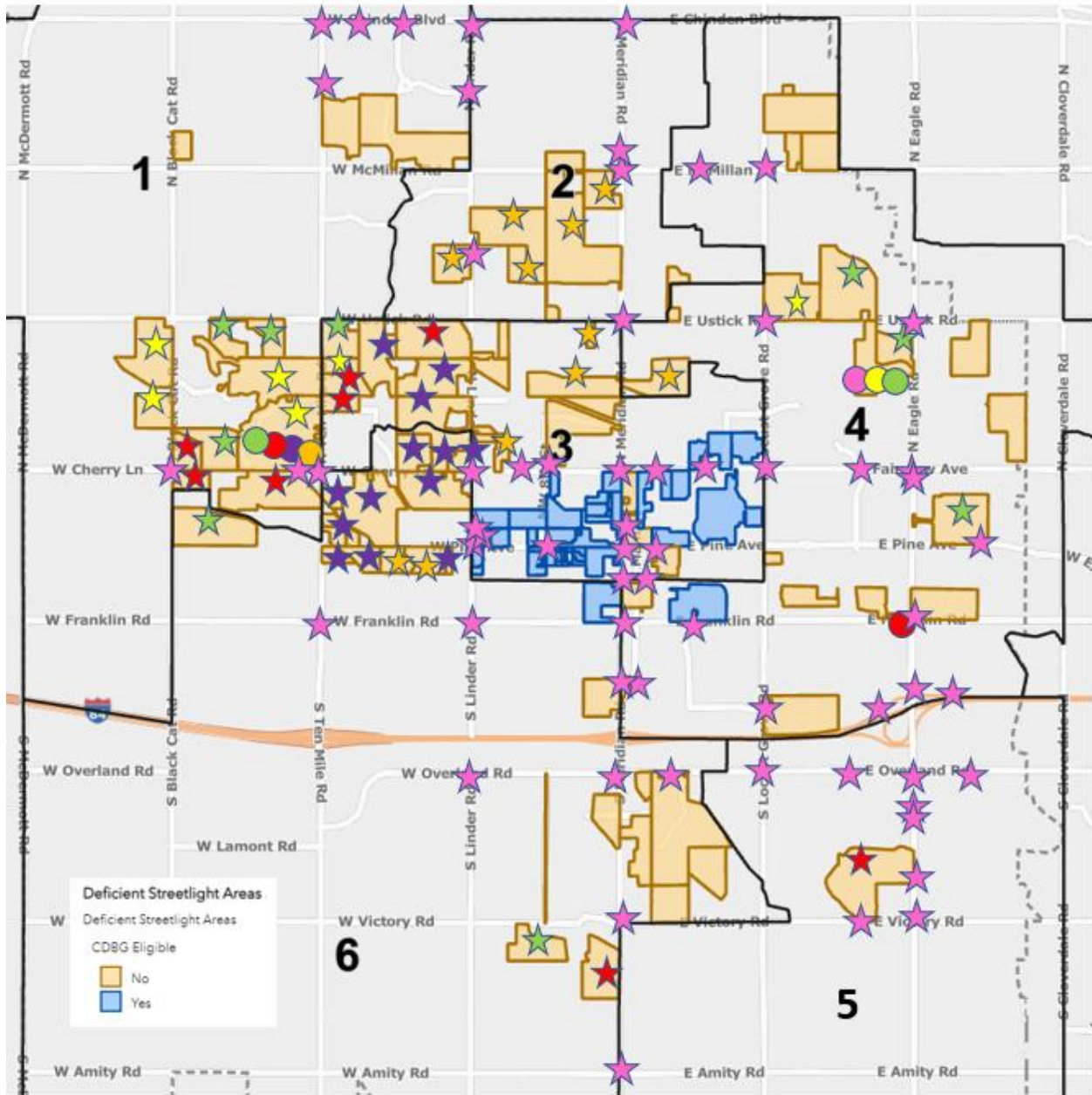

STREETLIGHT MASTER PLAN

FY2024 CIP

	Current CFP Budget	Estimated Number of Lights to Be Completed	Subdivision Location	District
LED *Meridian Intersection Pedestrian Safety Recommendation	\$164,000	182 Total	See List Below	See Below
Underserved Areas Base Budget- \$34,750 CFP- \$45,000	\$79,750	8	Carols (8 of 20)	4

Intersection LED Upgrade ★	# of HPS	District
Chinden and Fox Run	2	1
Chinden and Linder	3	1
Chinden and Long Lake Way	4	1
Cherry and Lauderdale	3	1
Cherry and Ten Mile	3	1
W Lost Rapids and Ten Mile	1	1
Cayuse Creek and Linder	4	1
Cherry and Black Cat	3	1
Chinden and Ten Mile	4	1
W Stone Valley Dr and Linder	1	2
Chinden and Meridian	4	2
McMillan and Meridian	3	2
Meridian Rd @ Heritage Middle	1	2
Ustick and Meridian	4	2
Pine and Meridian	2	3
Cherry and Linder	2	3
Cherry and NW 8th St	2	3
Fairview and Meridian	4	3
Cherry @ Meridian Middle School	1	3
Fairview and N Main St	4	3
Fairview and N Lake Pl	2	3
Pine and Main St	2	3
Broadway and Main St	3	3
Fairview and Locust Grove	3	3
Linder @ Meridian High School	1	3
Pine and NW 8th St	1	3
W State @ Meridian High School	2	3
Broadway and Meridian	1	3

STREETLIGHT MASTER PLAN

Carlton Ave and Meridian	1	3
McMillan and Red Horse Way	3	4
Pine and Parkdale Ave	3	4
Franklin and Stratford	2	4
Fairview and Eagle	4	4
Franklin and Meridian	3	4
Corporate Dr and Main St	4	4
Franklin and Eagle Rd	4	4
St. Luke's and Eagle Rd	4	4
Eagle and I-84 WB Onramp	2	4
Fairview and Hickory	2	4
Ustick and Locust Grove	4	4
Ustick and Eagle Rd	4	4
McMillan and Locust Grove	4	4
E River Valley St and Eagle Rd	4	4
E Central Dr and Locust Grove	1	4
Eagle and I-84 WB Offramp	1	4
Overland and Locust Grove	2	5
Franklin and Touchmark	4	5
Overland and S Wells Ave	4	5
Goldstone Dr and Eagle Rd	3	5
Overland and Eagle Rd	3	5
Overland and Silverstone	2	5
Victory and Brandy's Jewel Way	2	5
Victory and Eagle Rd	4	5
Easy Jet Dr and Eagle Rd	2	5
Eagle Rd South of Copper Point	2	5
Corporate Dr and Meridian	4	6
Franklin and Linder	3	6
Overland and Meridian	4	6
Overland and SE 5th Way	4	6
Victory and Meridian	3	6
Amity and Meridian	4	6
Franklin and Ten Mile	4	6
Overland and Linder	4	6
Pine and Linder	4	6

STREETLIGHT MASTER PLAN

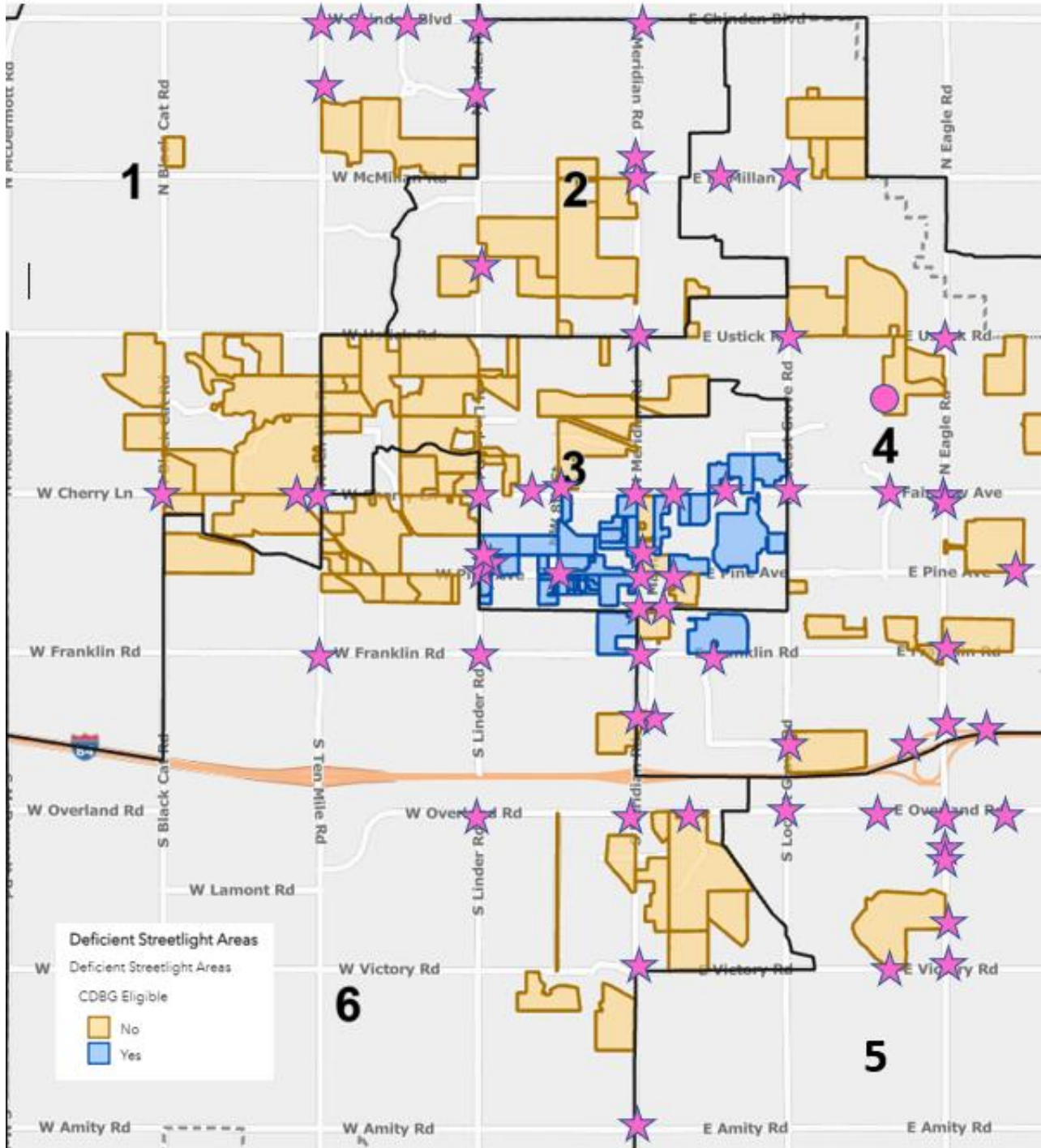

FY2024 Planned Underserved Areas 

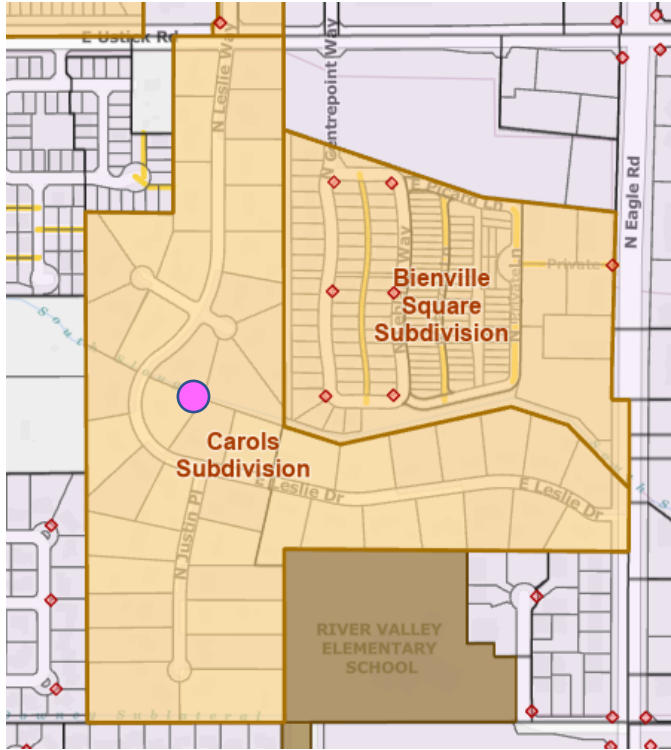

Selection Driver: Proximity to school, no lights

STREETLIGHT MASTER PLAN

FY2025 CIP

	Current CFP Budget	Estimated Number of Lights to Be Completed	Subdivision Location	District
LED	\$75,000	8 41 20 42 6 23	Cherry Lane Village Lake At Cherry Lane Turnberry Tricias Parkwood Meadows Summerfield	1 1 1 1 3 4
		140 Total		
Underserved Areas Base Budget- \$34,750 CFP- \$50,000	\$84,750	9	Carols (17 of 20)	4

FY25 Planned LED Upgrades ★

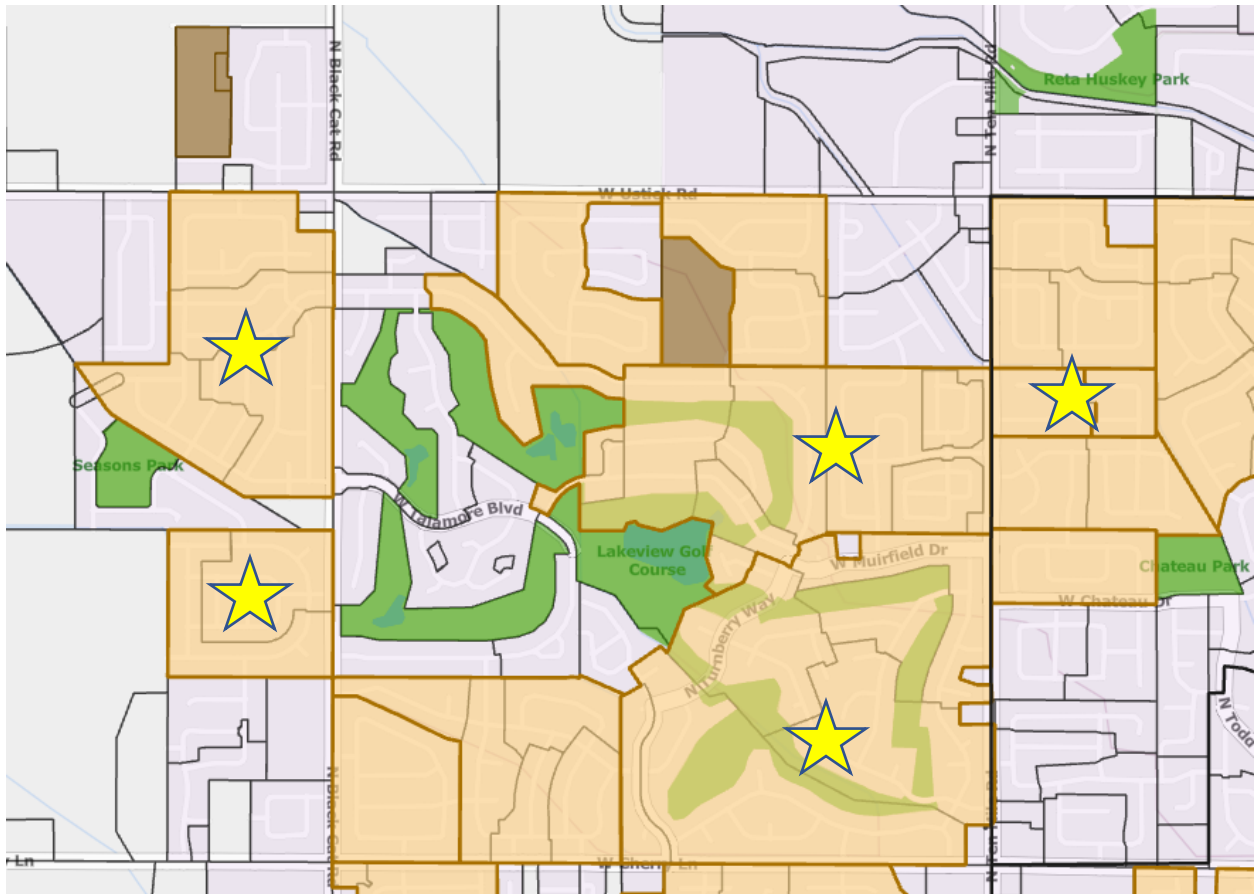

STREETLIGHT MASTER PLAN

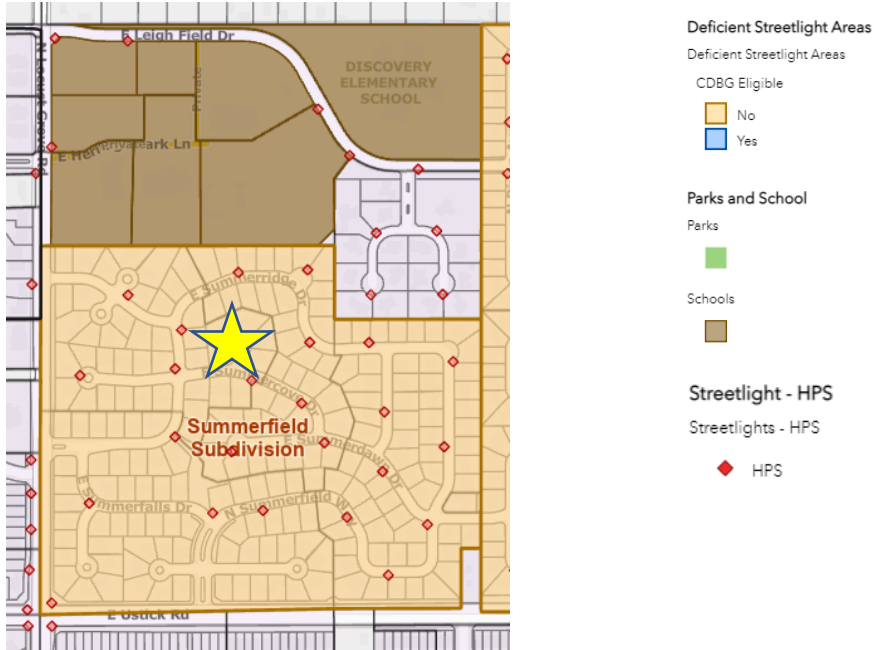

FY2025 Planned Underserved Areas

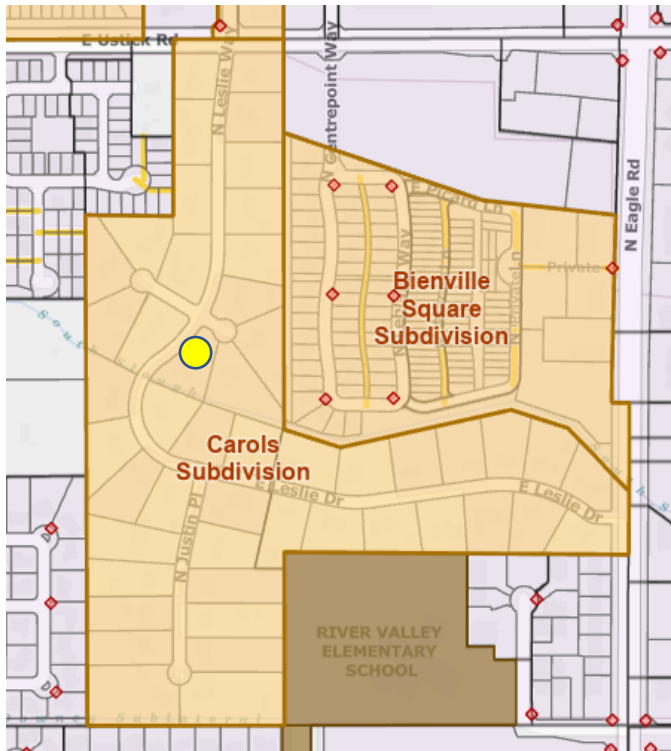

Selection Driver: Proximity to school, no lights

STREETLIGHT MASTER PLAN

FY2026 CIP

	Current CFP Budget	Estimated Number of Lights to Be Completed	Subdivision Location	District
LED	\$100,000	14 16 13 14 32 6 48 1 42	Wilkins Dakota Ridge Golf View Estates Candlelight Crossroads Bienville Champion Park Kentucky Ridge Castlebrook	1 1 1 3 4 4 4 6 6
		186 Total		
Underserved Areas Base Budget- \$34,750 CFP- \$50,000	\$84,750	3 6	Carols (20 of 20) Cherry Lane Village (6 of 105)	4 1

FY26 Planned LED Upgrades 

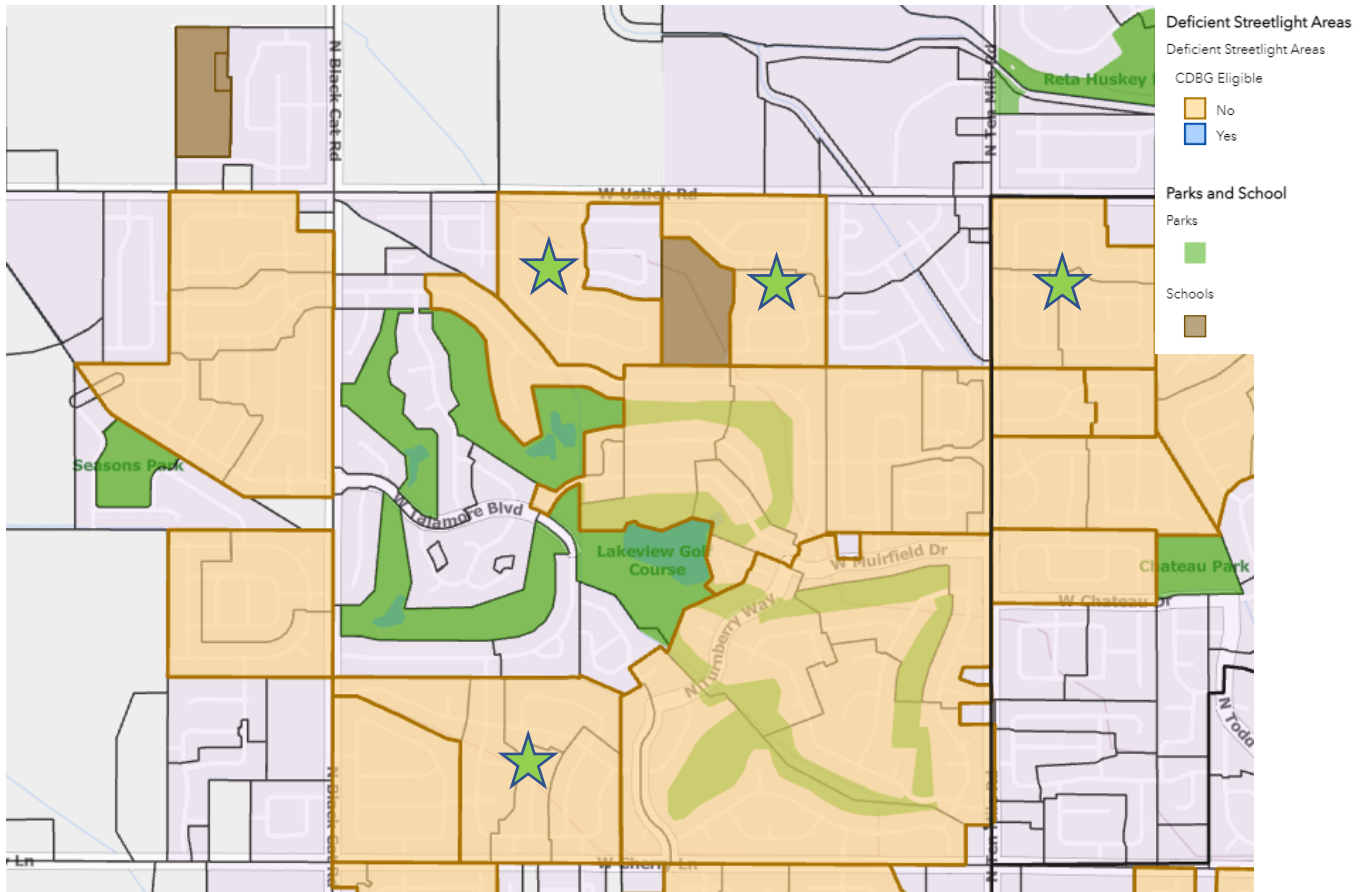

STREETLIGHT MASTER PLAN

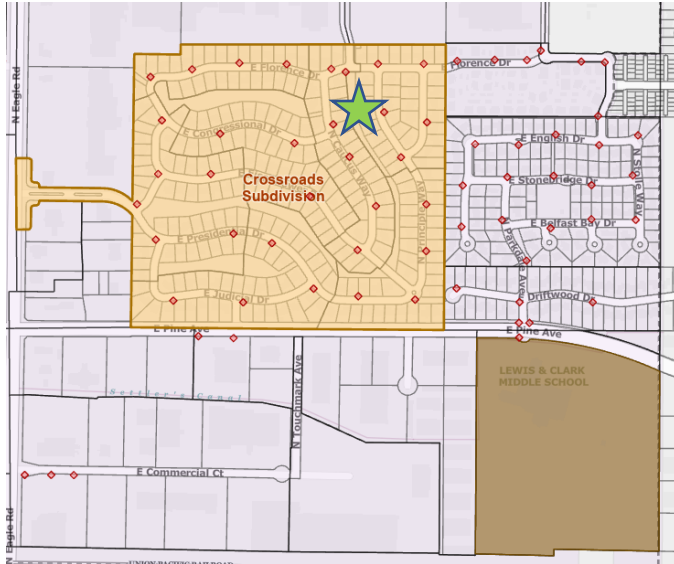

Deficient Streetlight Areas

Deficient Streetlight Areas

CDBG Eligible

- No
- Yes

Parks and School

Parks

Schools

- Parks
- Schools

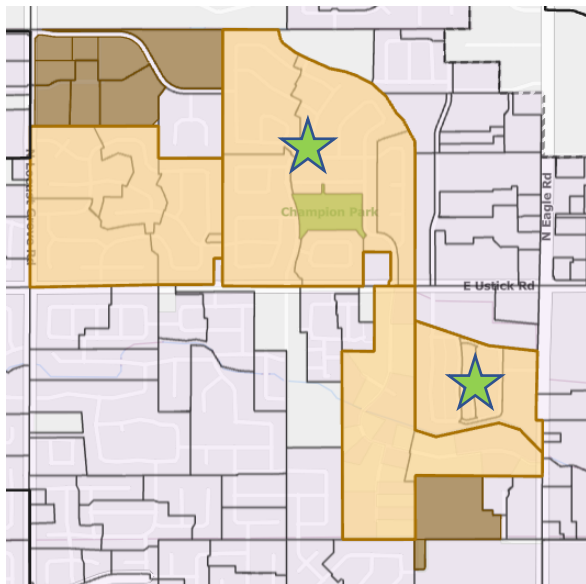

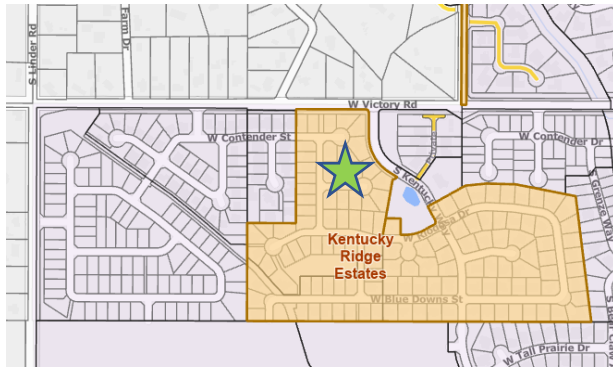

Deficient Streetlight Areas

Deficient Streetlight Areas

CDBG Eligible

No

Yes

Parks and School

Parks

Schools

Streetlight - HPS

Streetlights - HPS

HPS

FY26 Planned Underserved Areas ●

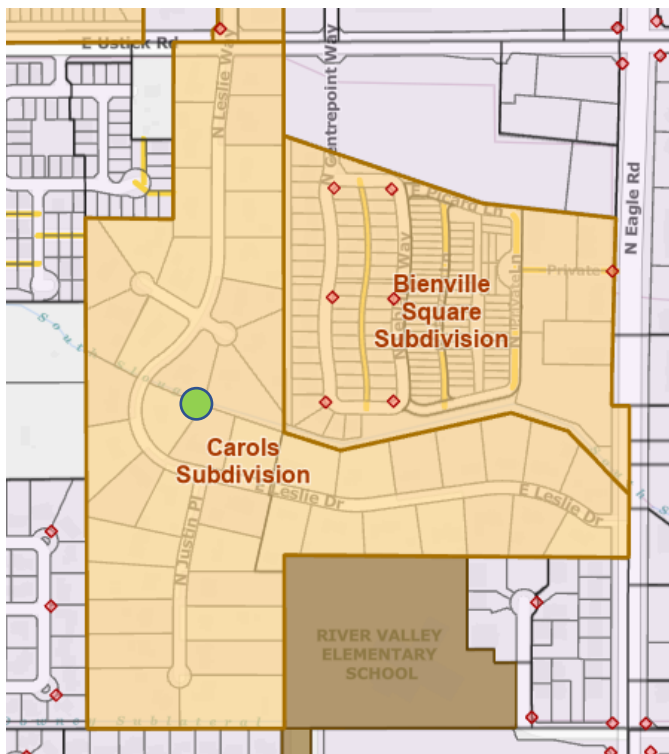

Selection Driver: Proximity to school, no lights

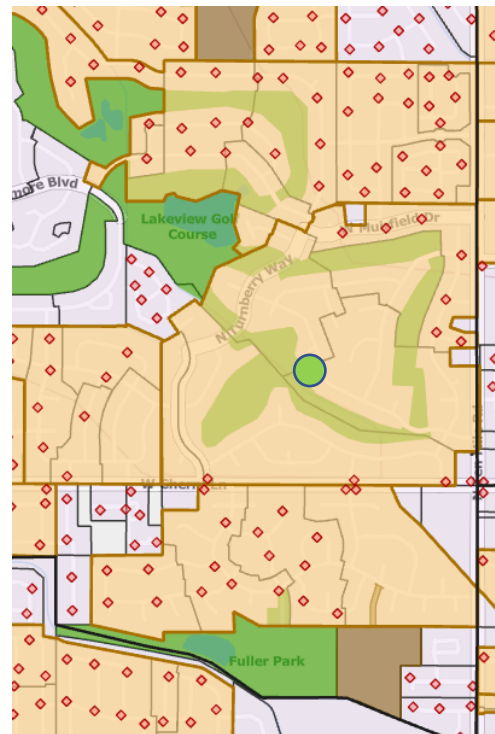

Selection Driver: Proximity to schools and parks, minimal existing lights

STREETLIGHT MASTER PLAN

FY2027 CIP

	Current CFP Budget	Estimated Number of Lights to Be Completed	Subdivision Location	District
LED	\$100,000	28	Rods Parkside	1
		11	Blackstone	1
		13	Milliron Place	1
		11	Tuthill Estates	3
		39	Tumble Creek	3
		7	Kentfield Manor	3
		65	Thousand Springs	5
		16	Meridian Heights	6
		190 Total		
Underserved Areas	\$84,750	4	W of Eagle- S of Franklin	4
Base Budget- \$34,750 CFP- \$50,000		2	(Arterial) Cherry Lane Village (8 of 105)	1

FY27 Planned LED Upgrades 

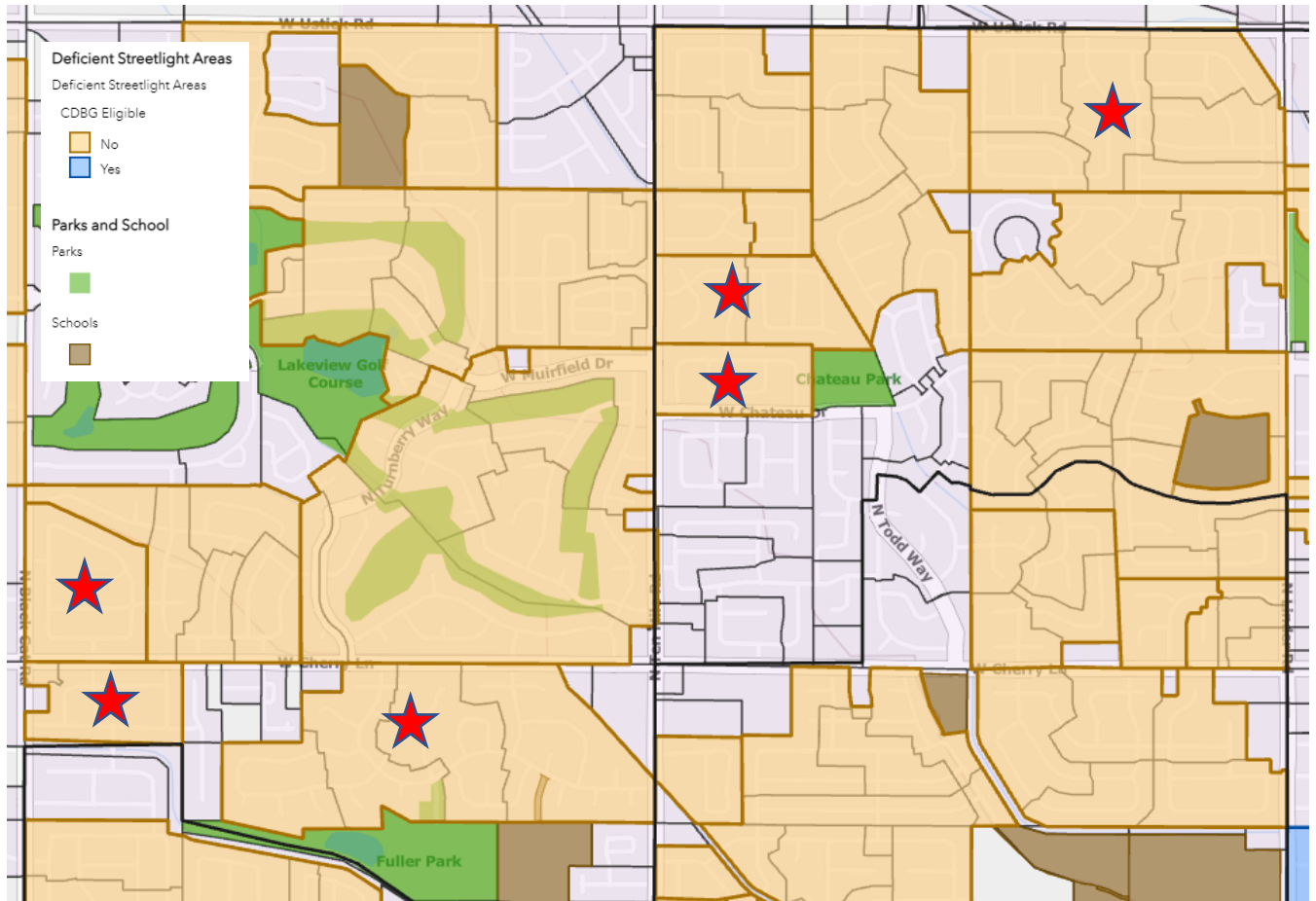

STREETLIGHT MASTER PLAN

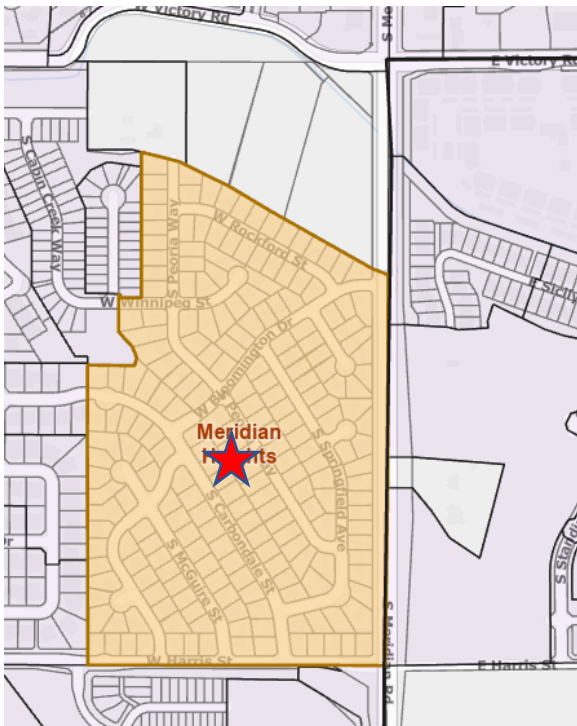
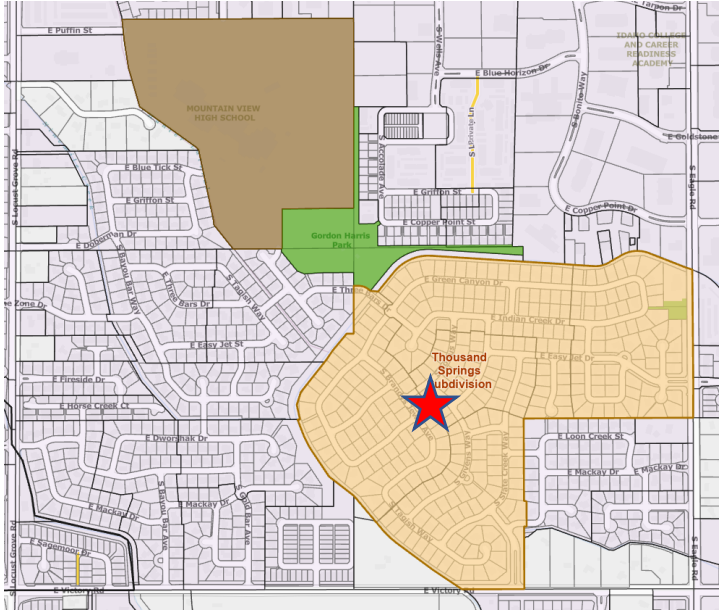

FY27 Planned Underserved Areas 

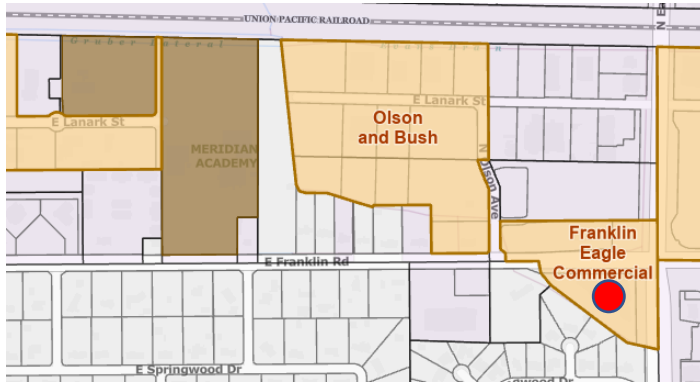

Deficient Streetlight Areas

Deficient Streetlight Areas

CDBG Eligible

No

Yes

Parks and School

Parks

Schools

Schools

Schools

Streetlight - HPS

Streetlights - HPS

 HPS

Selection Driver: Proximity to schools, arterial

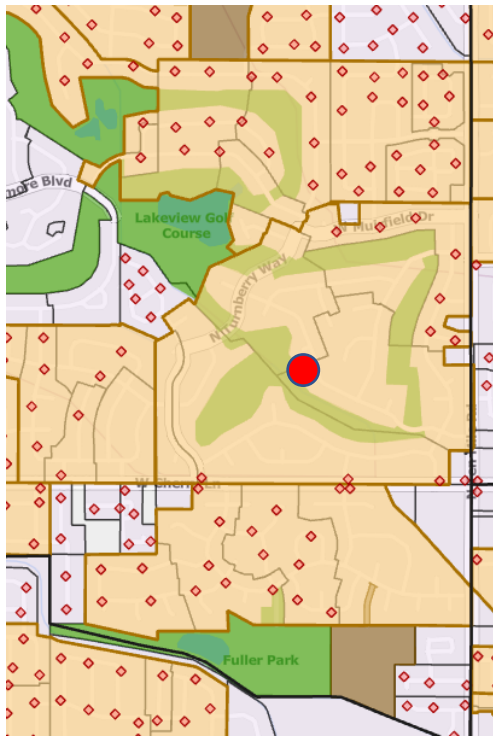

Selection Driver: Proximity to schools and parks, minimal existing lights

STREETLIGHT MASTER PLAN

FY2028 CIP

	Current CFP Budget	Estimated Number of Lights to Be Completed	Subdivision Location	District
LED	\$100,000	21	Fieldstone	3
		32	Turtle Creek	3
		14	Glenfield Manor	3
		11	One	6
		5	Valeri Place	6
		2	Cherry Crossing	6
		22	Vineyard	6
		5	Tiburon	6
		44	Haven Cove	6
		5	Thunder Creek	6
		7	Sommersby	6
		4	Lyndhurst Grove	6
		3	Courtyards At Ten Mile	6
		12	Canterbury Commons	6
3	Conifer	6		
Underserved Areas Base Budget- \$34,750 CFP- \$50,000	\$84,750	9	Cherry Lane Village (17 of 105)	1

FY28 Planned LED Upgrades ★

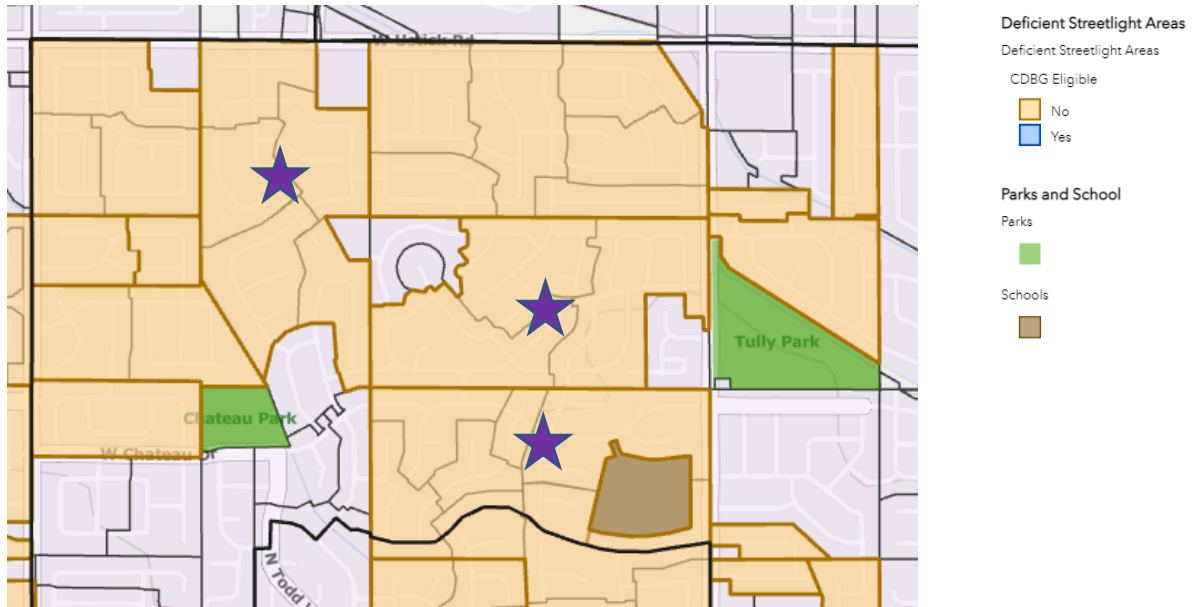

STREETLIGHT MASTER PLAN

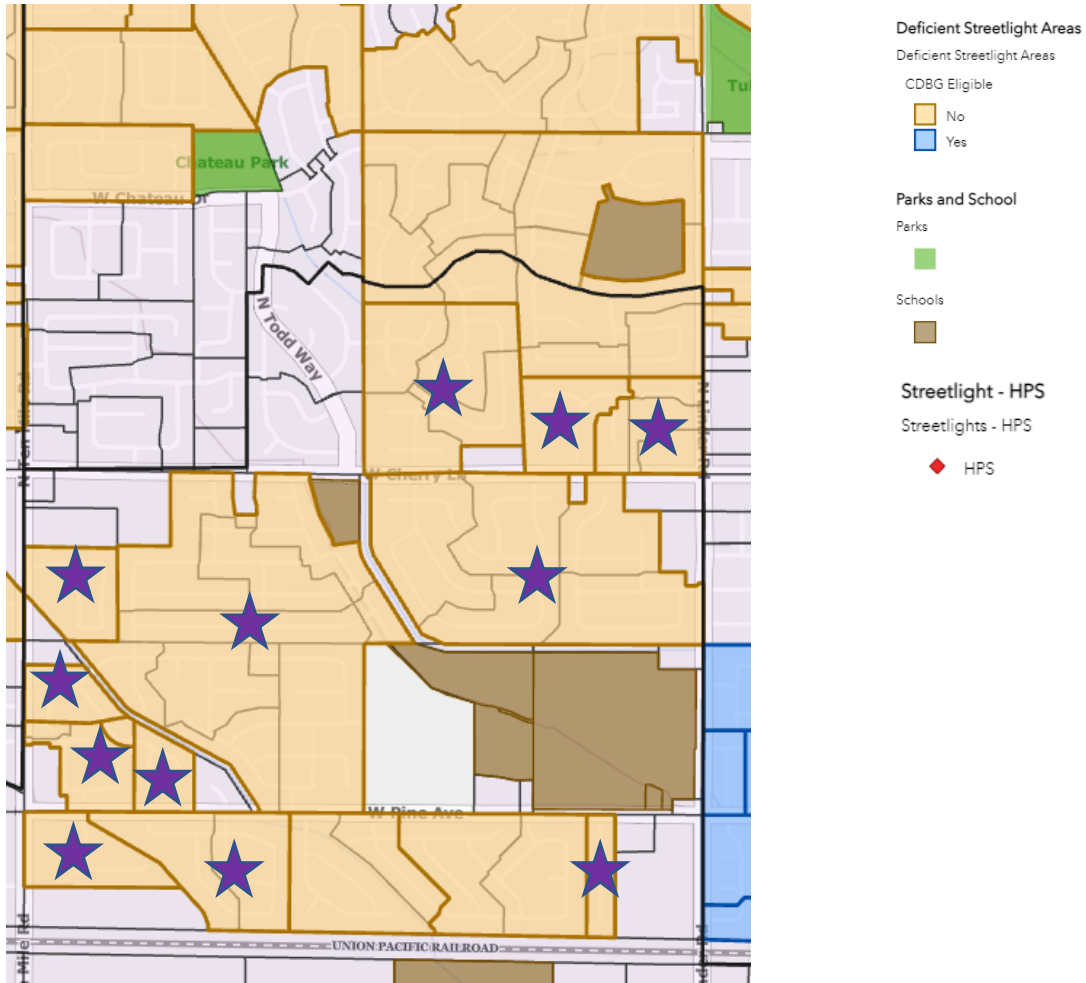

FY28 Planned Underserved Areas

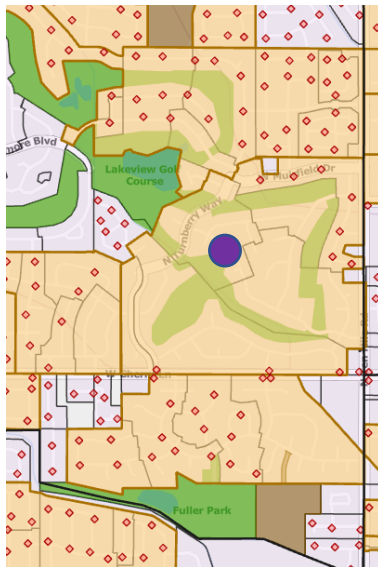

Selection Driver: Proximity to schools and parks, minimal existing lights

STREETLIGHT MASTER PLAN

FY2029 CIP

	Current CFP Budget	Estimated Number of Lights to Be Completed	Subdivision Location	District
LED	\$100,000	13 39 29 18 23 4 21 23 3 4 9 7	Sienna Creek Baldwin Park Cedar Springs Watersong Estates Ambercreek Dunten Place Waterbury Fothergill Pointe Parkway Southwick Morning Glory Merrywood	2 2 2 2 2 3 3 3 3 3 6 6
Underserved Areas Base Budget- \$34,750 CFP- \$50,000	\$84,750	9	Cherry Lane Village (26 of 105)	1

FY29 Planned LED Upgrades 

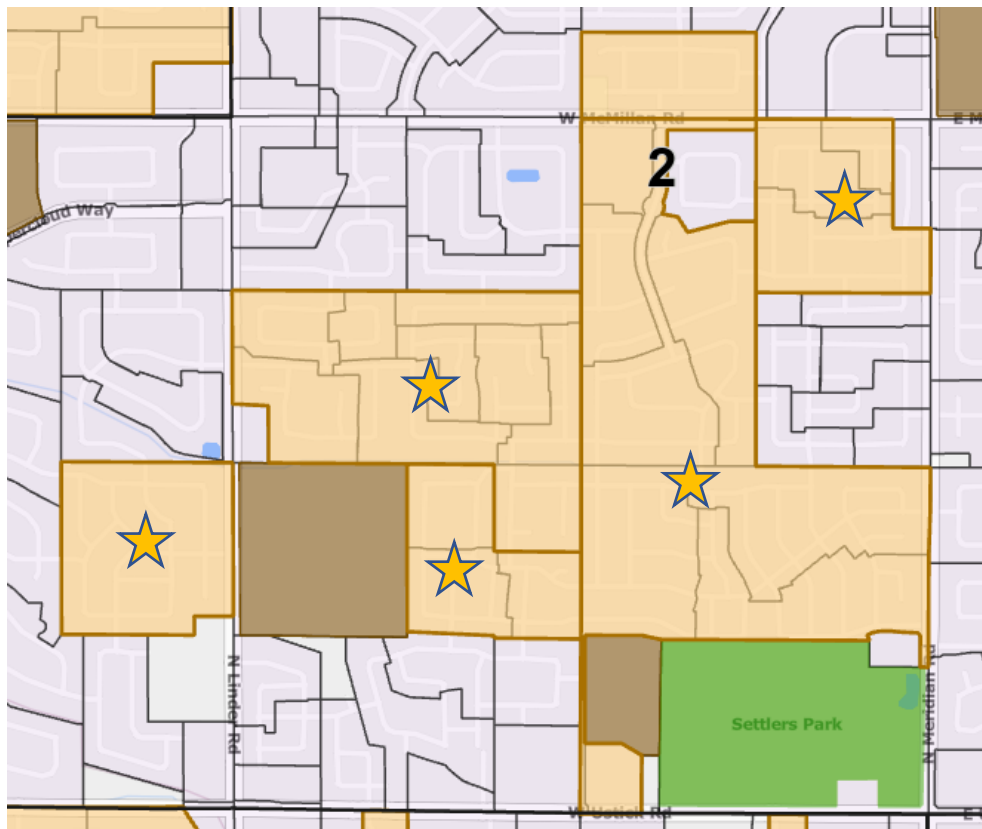

STREETLIGHT MASTER PLAN

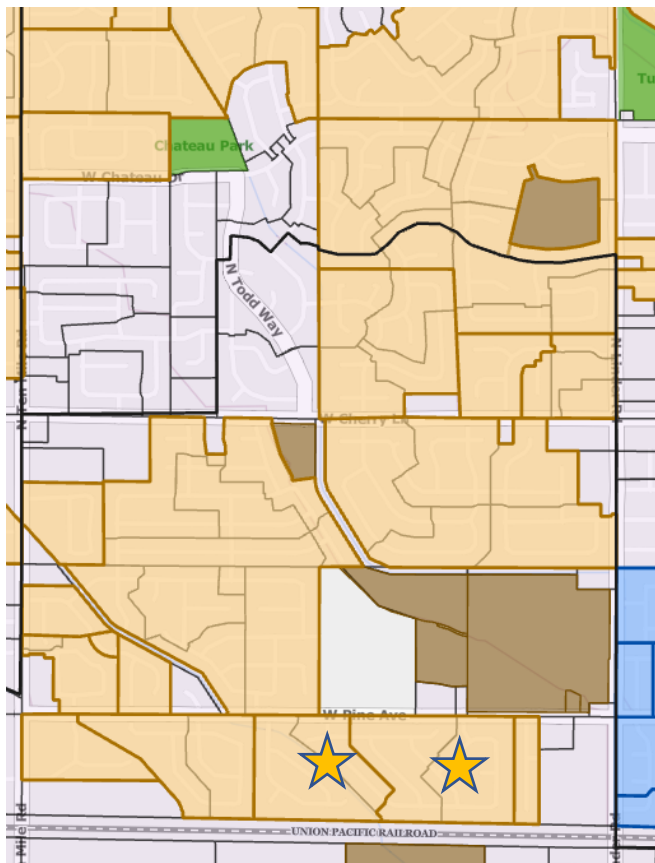
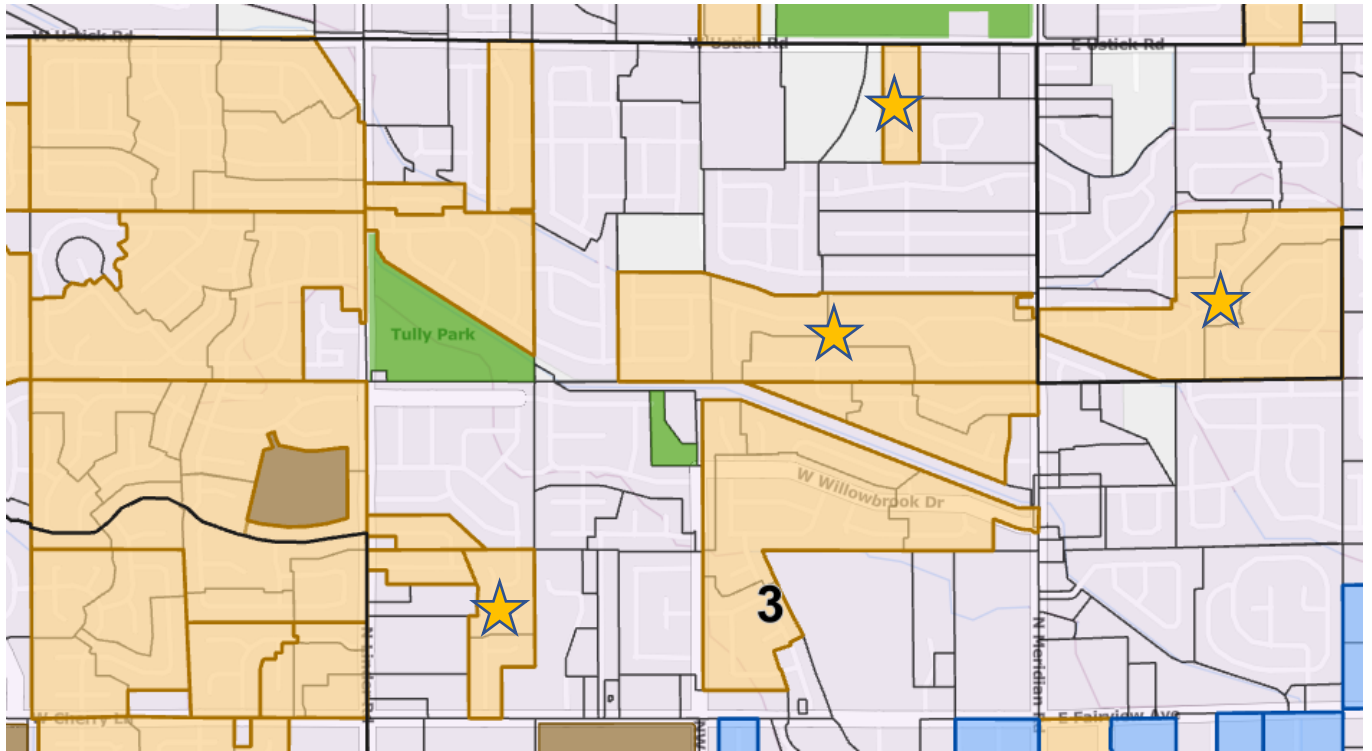

FY29 Planned Underserved Areas 

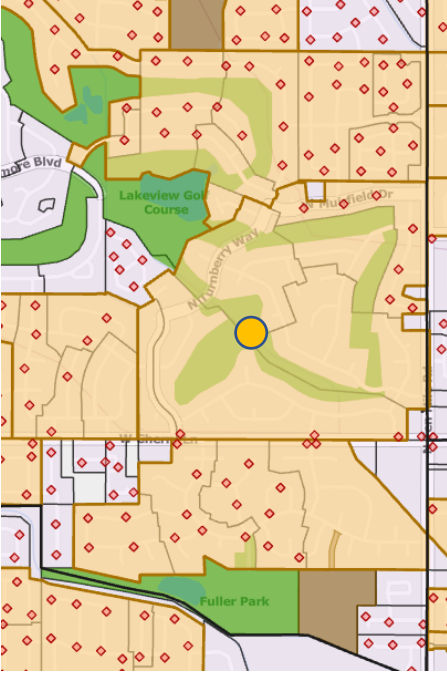

Selection Driver: Proximity to schools and parks, minimal existing lights

FY2030-FY2033

	Estimated Number of Lights to Be Completed	Subdivision Location	District
FY2030- LED	192	TBD	TBD
FY2030- Underserved	9	Cherry Lane Village (26 of 105)	1
FY2031- LED	192	TBD	TBD
FY2031- Underserved	9	Cherry Lane Village (35 of 105)	1
FY2032- LED	192	TBD	TBD
FY2032- Underserved	9	Cherry Lane Village (44 of 105)	1
FY2033- LED	192	TBD	TBD
FY2033- Underserved	9	Cherry Lane Village (53 of 105)	1

STREETLIGHT MASTER PLAN

CDBG Priority Plan (FY24-FY33)

Assuming ~\$89,000 in annual CDBG funding (not guaranteed).

	Estimated Number of Lights to Be Completed	Subdivision Location	District
FY2024- LED	49	Tremont Place, Piedmont, Canna Lilly,	3
		Applegate, Danbury Meridian Business Park	6
FY2024- Underserved	6	Westview Add to Meridian Sub (6 of 12)	3
FY2025- Underserved	9	Westview Add to Meridian Sub (12 of 12)	3
		Nidays Add to Meridian Sub (2 of 2)	3
		Fran Meridian (1 of 2)	3
FY2026- Underserved	9	Fran Meridian (2 of 2)	3
		Frost Add to Meridian Sub (8 of 14)	3
FY2027- Underserved	9	Frost Add to Meridian Sub (14 of 14)	3
		Danbury (3 of 3)	3
FY2028- Underserved	9	Promenade Cottages (9 of 40)	3
FY2029- Underserved	9	Promenade Cottages (18 of 40)	3
FY2030- Underserved	9	Promenade Cottages (27 of 40)	3
FY2031- Underserved	9	Promenade Cottages (36 of 40)	3
FY2032- Underserved	9	Promenade Cottages (40 of 40)	3
		Fairview Mixed II (4 of 6)	3
FY2033- Underserved	9	Fairview Mixed II (6 of 6)	3
		Gen Estates (7 of 27)	3

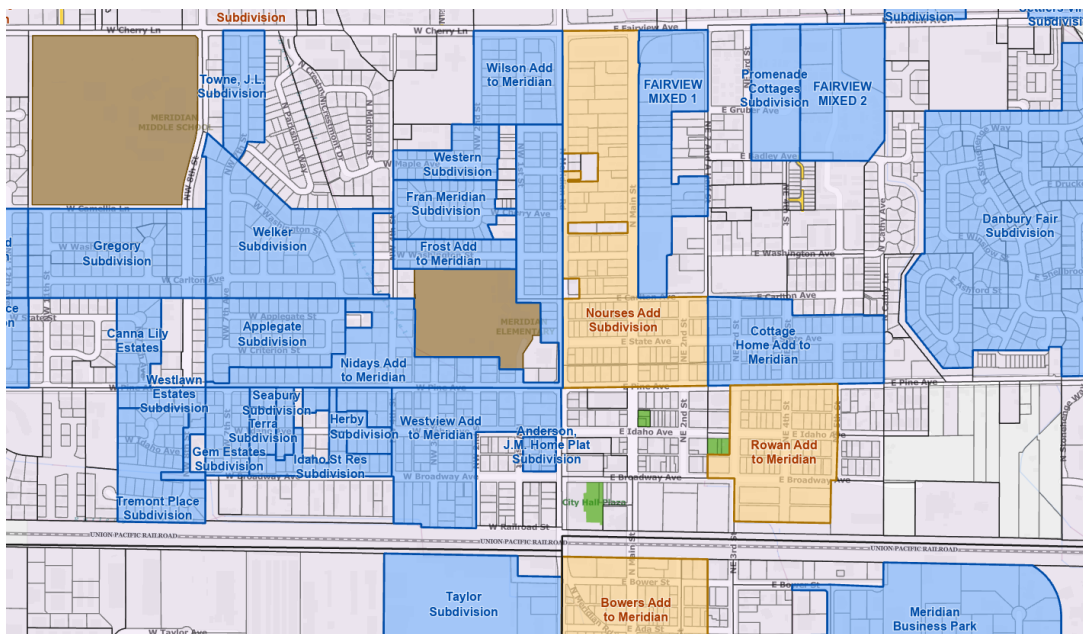

PW Budget Recommendation

In an effort to increase the number of lights upgraded and installed without adding additional staffing resources, the Public Works Department would recommend increasing the annual streetlight budget to the following levels.

- Underserved Area Lighting- Increase to \$100,000/year
- LED Lighting Upgrades- Increase to \$260,000/year
- Total- \$360,000/year

Additional work may be able to be completed without adding staff resources; however, it is recommended that the interim level be pursued for several years to ensure budget/project execution is possible.

Underserved Area Proposal- Enhanced Budgeted 2024-2033

	Underserved Budget	# of Lights Completed	% of Needed Lights Completed	Year to Complete Underserved
Current Budget	\$845,000 \$85K annual	89	5%	206
Phase 1 Recommended Increase	\$1,000,000 \$100K annual	105	6%	175
Max w/out Adding Resources	\$2,200,000 \$220K annual	232	14%	79

LED Upgrade Proposal- Enhanced Budgeted 2024-2033

	LED Budget	# of Lights Completed	% of Needed Lights Completed	Year to Complete LED Upgrades
Current Budget	\$1,064,000 \$100K annual	2046	42%	20
Phase 1 Recommended Increase	\$2,600,000 \$260K annual*	4,800	100%	8
Max w/out Adding Resources	\$2,600,000 \$260K annual*	4,800	100%	8

*Note: When LED upgrades are complete, funding could be diverted to Underserved Area Upgrades to continue to enhance that program.

Underserved Areas Plan



Underserved Areas (Needed Lighting Additions)

An underserved area is a neighborhood or area of the City that currently does not meet the City’s standards for street lighting. These areas may have some streetlights that are spaced too far apart and do not provide proper lighting or they may have no existing streetlights.

The City has identified ~1679 additional lights needed to bring all underserved areas up to current City lighting standards.

- ~987 Type II Lights (Residential)
- ~692 Type I Lights (Major Roadways/Arterials)

NOTE: ~349 of the lights identified above are Community Development Block Grant (CDBG) Eligible Lights

The following map shows the general areas of the City that have an underserved need.

District Number	Underserved Lights Needed
1	317
2	64
3	697
4	247
5	30
6	324

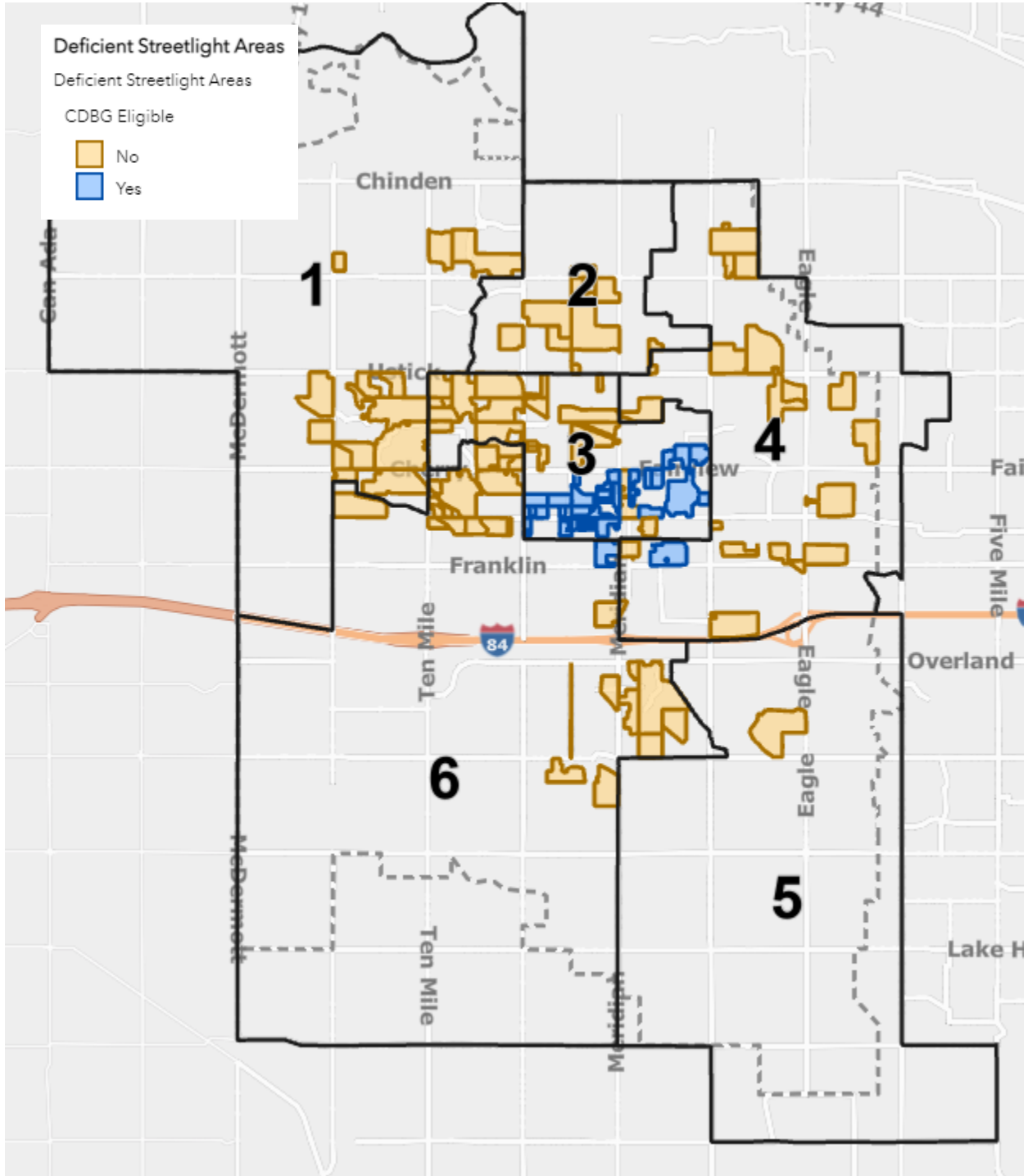

How Underserved Area Install Priorities Are Determined

The Meridian Public Works Department has historically utilized the following information for determining the priority of streetlight installation in deficient areas. The following factors are utilized in developing projects:

1. Proximity to schools
2. Traffic accidents
3. Crime
4. Crosswalks
5. ACHD five-year work plan

NOTE: It is generally not cost effective to upgrade or add lights on arterial roads that will be widened within five (5) years as they will be relocated and/or upgraded at that time. The City provides Future Install Agreements for developments that are being constructed prior to ACHD road widening projects within ACHD's five-year work plan.

See **Appendix F** for the more detailed underserved area lighting list.

Underserved Area Funding

The City funds the installation of new lights in underserved areas in two ways:

- City General Funds
- Community Development Block Grant (CDBG) Funds
 - CDBG is federal grant funding to support underserved or deficient low- to moderate-income communities in a variety of ways including upgrading utility infrastructure. The City sometimes utilizes these funds for adding and upgrading streetlights in eligible areas.
 - Historically, the City receives approximately \$500,000 in CDBG funding annually. Approximately \$20,000 is used for administrative fees and \$75,000 is used for other public services. The remaining \$405,000 is split between housing projects and public facility/infrastructure projects.
 - The annual average CDBG funding that has been applied to streetlight projects over the past 13 year is approximately \$89,000 per year.

Completed/Pending CDBG Funded Projects

Project Year	CDBG Project Name	Amount	Number of Lights Added
2011	W 8th St Pedestrian Lighting	\$64,584	Not tracked
2016	Low/Moderate Income Area	\$182,507	Not tracked
2017	Low/Moderate Income Area	\$125,000	14
2019	E Chateau/Chief Joseph Streetlights	\$61,178	26
2019	Crestwood/Fenway Streetlights	\$50,000	23
2019	MMH/MMS Streetlights	\$115,662	18

STREETLIGHT MASTER PLAN

2021	W Chief Joseph Streetlights	\$180,000	19
2021	Locust Grove and Pine Streetlights	\$ 80,000	6
2022	E MHS/MMS Streetlights	\$ 99,000	TBD
2023	Franklin and 7th Streetlights	\$100,000	TBD
2023	Landing Subdivision Streetlights	\$ 97,423	TBD

Underserved Area Progress

	Allocated	Actual Spent	# of New Lights
FY2021	\$262,000 \$45K FY2021 budget request + \$217K CDBG	\$176,000	40
FY2022	\$225,000 \$45K FY2022 budget request + \$35K base budget + \$145K CDBG + \$112K carry forward	\$218,000	75
FY2023	\$277,000 \$45K FY2023 budget request + \$35K base budget + \$197K CDBG + \$87K carry forward	\$1,200 YTD	85 in progress CDBG Lights in progress
Cumulative Totals	\$764,000	\$395,200	115 complete Estimate - 200 by end of FY2023

The City has been able to spend about 52% of the allocated budget to date. Reasons for this include staffing resources (design and project management), supply chain issues, and contractor availability.

As installation prices continue to increase, the number of lights that can be installed per year with the flat level of funding decreases.

Future Funding Needs

At 2023 pricing (in-house design, material, and labor), it costs approximately \$9,500 for installation of a new Type II light and \$16,500 for a new Type I light.

Type	# of Lights	Cost	Needed Funding
Type I	692	\$16,500	\$11.4 M
Type II	638	\$9,500	\$6.1 M
CDBG Eligible, Type II	349	\$9,500	\$3.3 M-CDBG
Total Underserved Area Funding Needed			\$17.5 M +\$3.3 M CDBG

Planned Funding (FY2023-FY2033)

Fiscal Year (FY)	Planned Annual CFP + Base Budget (General Fund)	Anticipated Annual CDBG Request	Total Annual Underserved Area Planned Funding
2024	\$80,000	\$89,000	\$169,000
2025-2033	\$85,000	\$89,000	\$174,000
Total Planned Funding (Including CDBG)			\$1.7 M
Total Planned Funding (Excluding CDBG)			\$845K

With approximately \$85,000 in funding annually, the City can add approximately 9 residential type streetlights or 5 major/arterial lights.

At the current level of City general funded levels (~\$85,000/year), it will take over 100 years to complete just the residential (Type II) lighting.

At the current level of CDBG funding, all CDBG eligible lights should be installed by 2060 (~37 years).

Additional funding sources, as well as program resources (staffing for project design and project management), will need to be added if the City wants to accelerate these installations at some point in the future.

LED Conversion Plan



HPS to LED Conversion Program

Currently, the City is responsible for paying the power for 8,595 lights.

Currently, about 4,827 of the City streetlights are High Pressure Sodium (HPS) fixtures. The City pays a higher amount for the power usage on these fixtures as well as higher maintenance costs. The City generally has two types or wattages of HPS bulbs: 100W and 250W.

Changing to LED lighting will reduce the life cycle and operating costs of the street lighting system. LED lighting requires significantly less power than legacy sources, such as high-pressure sodium, reducing the lifecycle energy costs of the system. With a lifespan of up to 100,000 hours, LEDs need to be replaced significantly less often than HPS luminaires, reducing maintenance costs.

As of June 1, 2016, all newly installed streetlights are required to be LED.

LED Upgrade Progress

	Allocated	Actual Spent	# of LED Conversions	Estimated Annual Power Savings	Estimated Annual Maintenance Savings
FY2021	\$250,000 \$250K budget request + \$33K carryforward	\$125,000	276	\$2,997	\$4,921
FY2022	\$375,000 \$375K budget request + \$110 carry forward	\$116,000	360	\$3,910	\$6,419
FY2023	\$75,000 \$75K budget request + \$400K carry forward	\$183,000 YTD	403 complete 219 in design	\$6,628	\$10,983
Cumulative Totals	\$733,000	\$424,000	1,039 complete Estimate – 1,252 by end of FY2023	\$13,535	\$22,323

The City has also received approximately \$34,000 in Idaho Power rebates for lights completed in FY2021-FY2023 for LED conversions.

The City has been able to spend about 58% of the allocated budget to date. Reasons for this include staffing resources (design and project management), supply chain issues, and contractor availability.

As such, the Public Works Department asked for a smaller budget in FY2023 anticipating a large carryforward. Public Works is working on designing and contracting out the remaining \$292,000 in FY2023.

Annual Savings Calculations - Power and Maintenance

When converting HPS to LED lights, there are four major components that result in long term cost savings:

- Reduced wattage requirements
 - 100W HPS can be replaced with 50W LED
 - 250W HPS can be replaced with 100W LED
- LED lights use less energy, costing less to operate
- LED lights generally require less routine maintenance
- LED lights have a longer total lifespan requiring less frequent replacement

STREETLIGHT MASTER PLAN

	100W HPS	50W LED	Total Annual Ongoing Savings with Full Conversion
Annual Power Cost	\$27.32	\$16.46	4,323 lights x \$10.86= \$46,948
Annual Maintenance Cost	\$22.00	\$4.17	4,323 lights x \$17.83= \$77,079
			\$124,027

	250W HPS	100W LED	Total Annual Ongoing Savings with Full Conversion
Annual Power Cost	\$56.00	\$23.07	504 lights x \$32.93= \$16,597
Annual Maintenance Cost	\$43.00	\$6.67	504 lights x \$36.33= \$18,310
			\$34,907

*NOTE: 248 lights missing in GIS database - assuming they are 250W HPS

With a full system conversion to LED lights, the City could save approximately \$159,000 in ongoing annual power and maintenance costs. These funds could potentially be reallocated to fund additional underserved area additions.

NOTE: Annual maintenance costs were calculated using the following:

- 100W HPS \$110 every 5 Years
- 250 W HPS \$215 every 5 Years
- 50W LED \$50 every 12 Years
- 100WLED \$80 every 12 Years

NOTE: Annual power costs were calculated using the following:

- 100W HPS \$27.32
- 250 W HPS \$56.00
- 50W LED \$23.07
- 100WLED \$16.46

Funding Needed

At 2023 pricing (in-house design, material, and labor), it costs on average \$520 for conversion to LEDs.

Cost to Upgrade to LED Type II \$480/light

Cost to Upgrade to LED Type I \$560/light

Type	Lights Remaining to Upgrade	Average Cost to Upgrade	Needed Funding
100W HPS	4,323	\$520	\$2.2 M
250W HPS	504	\$520	\$262 K
Total LED Conversion Funding Needed			~\$2.5M

As installation prices continue to increase the number of lights that can be converted per year with the flat level of funding decreases.

Planned Funding (FY2023-FY2033):

Fiscal Year (FY)	Planned Annual CFP LED Conversion Funding (General Fund)
2024	\$164,000*
2025-2033	\$100,000
Total Planned Funding	\$1.06 M

*Note: Increase from standard amount to address intersection HPS conversion recommendation from the Meridian Intersection Pedestrian Safety Task Force.

With approximately \$100,000 in funding annually, it will take approximately 20 years to complete this conversion process. At this funding rate, about 192 lights can be converted annually.

After all streetlights have been converted to LED, the \$100,000 annual funding could be reallocated to underserved area new lighting installations.

Alternatives Analysis

- City of Boise's approach - Convert all LEDs at once
 - The City of Boise decided to convert their remaining HPS lights to LED in one large project. They had around 2,500 HPS streetlights that needed to be upgraded to LED. They spent several months developing the project scope with construction maps. The project was sent out to bid in order to upgrade all of the lights at once. When all was completed, it cost them \$900,000 for 2,500 streetlights and was complete six (6) months after the contractor received the materials for the project.
 - In order to do this approach, the City would need to dedicate approximately \$2.2M and utilize external design and project management resources.
 - Installation bubble
 - While not a huge issue, the City should be aware of creating an installation bubble that could cause future maintenance, repair, and replacement concerns in the future.

Return on Investment

Converting from HPS to LED lights has long term financial benefit to the City. Savings are based on reduced electricity and maintenance costs for LED lights. For each 250W HPS light the City converts, they save approximately \$69/year. For each 100W HPS light the City converts, they save approximately \$29/year.

However, there are important staffing, project management, and design constraints that exist when contemplating these conversions.

- Estimated maximum annual conversions current TUC position can complete: 500 lights = \$260,000
- If additional conversions are desired, additional resources are required:
 - Adding consultant resources which increase costs by 20%
 - Adding a Streetlight Coordinator position which includes a \$117,000 fully loaded annual cost

Public Works would recommend increasing LED conversion funding to \$260,000 and completing approximately 500 conversions per year. Under this model, conversions would be completed in about 8 years with a nearly \$980,000 savings over a 20-year period.

<u>Model 1: Baseline \$100K/Yr</u>		<u>Model 2: \$260K/Yr</u>	
Costs	(\$3,344,330.64)	Costs	(\$3,700,245.83)
Benefits	\$3,532,852.98	Benefits	\$4,679,860.95
Delta	\$188,522.33	Delta	\$979,615.12
BCR	1.06	BCR	1.26
Years to Payback	19	Years to Payback	15
Years to Convert	20	Years to Convert	7

The ROI model should be evaluated regularly based on actual program progress, staffing resources, power costs, maintenance costs, and Idaho Power rebates.

Streetlight Program Constraints

The current City of Meridian Streetlight Program has several key constraints that will need to be evaluated and potentially addressed over time. Current constraints are listed in order of priority/program impact.

Personnel Considerations

As noted in several of the previous sections (Underserved Areas Plan and LED Conversion Plan), a constraint in advancing the City’s street lighting program is internal staffing resources.

The Streetlight Program has grown substantially since the Public Works Department took over the program in 2010. In 2010, the City had 3,366 streetlights that were all operated and maintained by Idaho Power compared to the over 8,595 that the City operates and maintains today.

The City currently has a single staff resource (Transportation and Utility Coordinator-TUC) who dedicates about half of their time to street lighting and half their time to transportation/utility coordination. The Public Works Department is currently conducting a time study to better evaluate the TUC’s time spent on various program elements in an effort to better forecast future programmatic needs.

As the day to day responsibilities continue to grow, the Transportation and Utility Coordinator will be further limited in their ability to plan future streetlight upgrades and maintain the current level of service. As a single staffing resource, there is not adequate time to design and oversee significantly more upgrade and replacement projects.

A dedicated Streetlight Program Coordinator position could enable the City to improve the timeline on LED replacements and installing lighting for underserved areas. A potential alternative option is to outsource some additional new streetlight designs to a local consulting firm. In addition to time delays, approximately 15-20% of the project budget is consumed by the design firm, reducing the number of streetlights that can be installed or upgraded with a flat level of funding. There is also still an internal constraint of project management and purchasing management that cannot be outsourced.

For context, the following table compares staffing resources dedicated to streetlighting amongst the larger neighboring cities. Values were obtained through meetings with the various cities.

	City of Meridian	City of Boise	City of Nampa	City of Caldwell
Number of Streetlights	8,600	10,200	6,400	7,000
Approximate # of Streetlights Added Per Year	300	300	100	100
Utility Coordinator(s)/ Designer(s)	0.5	1- Streetlight Manager 2- Transportation Coordinators 1- Utility Coordinator	2	1
In-House Streetlight Electrician(s)	None	1- Streetlight Technician NOTE: Boise is also in the process of bringing maintenance	5	1

STREETLIGHT MASTER PLAN

	City of Meridian	City of Boise	City of Nampa	City of Caldwell
		in-house due to the current market price bids received from the local contractors.		
Administrative Assistant(s)	0.5	1	0.5	1
Streetlight Inspector(s)	.25 Electrical Inspectors partially complete	1	0.25	0.5
Streetlight Locator(s)	.25 Water Division FTEs complete this	1	0.25	0.5
Total FTEs	1.5 FTEs	7 FTEs	8 FTEs	4 FTEs

In-House Repair/Maintenance/Inspection Evaluation

In-House Streetlight Electrician (Maintenance, Repair, and Inspections) (NEW)

One of the 5-year work plan goals of the Public Works Department will be to evaluate the benefits of potentially adding an additional FTE (Streetlight Electrician) that would be able to handle inspections, maintenance, repairs, and LED upgrades in-house.

Inspections/GPS

Currently streetlight construction inspection is performed by the Community Development Department Building inspectors. Following the final inspection, the Public Works water and sewer line inspectors collect the GPS data for the mapping database. By the time a final inspection is performed and the PW inspectors arrive to GPS streetlights, the conduit is buried and cannot accurately be located. It is an unnecessary cost to the City to have two (2) separate inspection teams visit every new streetlight. In order to eliminate separate inspection teams at each project, the City could develop its own Streetlight Electrician position that can also perform the inspections to help eliminate issues created by having multiple inspection teams, a situation which has historically led to misinformation and lack of necessary data. The Streetlight Electrician would GPS the underground power while performing the rough-in electrical inspection (this is not presently happening and current information is based on assumption).

Maintenance/Repairs/Upgrades

The City of Meridian currently outsources its streetlight maintenance program to a small, local electrical firm. This small local electrical contractor has allowed the City to keep maintenance and repair costs relatively low. The current sourced maintenance contract with the City’s current electrical contractor is approximately \$41K per year. At the time of the award of this contract (2020), only one additional local contractor bid on the City’s maintenance contract for a total of \$68K which is a 65% increase from our current contract.

It is estimated that an in-house maintenance program would require the following resources and associated funding. However, these costs would be offset by the reduction in outsourced service. Additionally, this position could potentially perform LED retrofits, allowing the City to accelerate the LED conversion program.

STREETLIGHT MASTER PLAN

	Expected Costs	Frequency
Streetlight Maintenance & Repair Electrician Salary/Benefits	\$117,000	Annually
Start-up Tools/Equipment, Supplies, PPE	\$18,000	One Time
Electrical Bucket Truck (Quote from January 2022)	\$118,750	One Time
Vehicle Maintenance, Repair, Fuel	\$3,500	Annually
Introductory Inventory (Poles, Mast Arms, LED Fixtures, HPS Parts, etc.)	\$56,500	Start up (will adjust with demands throughout the year)
Total Startup Cost:	\$313,750	
Annual Operations: (not including materials)	\$120,500	

While it currently does not likely make sense to bring this position in-house, this should be reevaluated as the costs of outside contracted services continues to rise.

Budget

One of the current challenges with advancing the City’s Streetlight Program is overall program funding levels. Because streetlights are currently funded out of the City’s General Fund, there are significant and equally important competing priorities for both one-time and ongoing funding.

	Annual Budget	Ongoing or One Time Expense	Funding Mechanism	Projections	Funding Level Adequacy
Annual Operating Expense (Power)	\$328,000	Ongoing	General Fund (GF)	Expected to decrease with LED conversions. <ul style="list-style-type: none"> ▪ System growth will continue to add demand/cost. 	Adequate
Annual Maintenance & Repair	\$75,000	Ongoing	GF	Expected to decrease with LED conversions. <ul style="list-style-type: none"> ▪ System growth will continue to add demand. ▪ Expected to increase with third party contractor retiring. ▪ Currently no preventative (only reactive) maintenance/ repairs occurring. 	Potentially Underfunded
Staffing	\$117,000 TBD	Ongoing	GF	Future Streetlight Coordinator (placeholder in 2025 CFP) Future Streetlight Electrician/Inspector (not in CFP yet)	NA

STREETLIGHT MASTER PLAN

Underserved Area New Lights	\$85,000 \$89,000	One-time One-time	GF CBDG	Long term (100+ year) need at current funding levels; may need increased. <ul style="list-style-type: none"> ▪ Unit costs will also increase over time. 	Potentially Underfunded
LED Conversions	\$100,000	One-time	GF	Short term (1-20 years) need depending on funding level. Costs will end once conversions are complete.	Potentially Underfunded

Data Accuracy

Streetlight data is currently tracked in numerous locations which making difficult to manage and errors more likely. The primary location for tracking is in the City’s GIS database where there is a substantial amount of missing data from streetlights. Over the past 6 months, the Transportation and Utility Coordinator has fixed thousands of missing and/or incorrect datapoints in the GIS system.

Over the years, there have been numerous errors in labeling streetlights. Currently, the City has over 9,500 streetlights in its database beginning with number 1 through 56112. This has led to confusion. There is currently no background information for streetlights numbered prior to 40000. There were over 500 streetlights in the database that had duplicate and even triplicate numbers which made it difficult to accurately work with outage reports, maintenance, and billing. The Transportation and Utility Coordinator has corrected all of these duplicate numbers and put in place a safeguard to assist in preventing future duplications.

IPS is the City’s asset management system currently used for all of its public works infrastructure assets. This is a fully integrated system that tracks the City’s assets for sewer and water. The City has had numerous delays with incorporating streetlights into its IPS database. Lack of staffing and other projects priorities have led to many of these delays.

Once streetlight data is ready to be transferred to IPS, it will pull all of the required data necessary for tracking maintenance, repair, billing, and outage reports directly from the GIS database. Benefits of using IPS for all streetlight-related data include:

- One centralized location for tracking streetlight information
- One centralized location to find the remainder of the errors, incorrect data, and missing data that needs to be corrected
- Track billing schedules and billing contract numbers with Idaho Power
- Create outage reports and damage claims without having to search multiple locations for correct information
- Create scheduled maintenance program for inspections and preventative maintenance
- Track warranty information and schedule inspections prior to warranty expiration dates
- Identify duplicate streetlight numbering
- Eliminate storing information in multiple locations and simplifying processes (new streetlights, outage reports, damage claims, billing errors, missing and corrupt data, warranty information)

City staff are currently working on cleaning up as much data as possible to ensure a clean transition to IPS; however, it is an extremely long process including searching multiple locations for correct data. Many times, this leads to visiting the streetlights in the field to find the correct information. There is currently not enough GIS support staff to clean up the GIS database or input new streetlights. As of October 2022, there were 34 new subdivisions that are in the queue to complete GIS data in the current database with another 56 waiting for final submittals from contractors.

An additional benefit of tracking streetlights in IPS will be an improved warranty inspection program. The supplemental specifications require a two (2) year warranty on contractor installation. Fixtures and photocells are required to have a ten (10) year factory warranty. Once the Streetlight Program is fully integrated into the City's asset management database, the City will set a regular maintenance schedule for all streetlights. The City will set an 18-month inspection for all new installations to ensure they are fully operational prior to the two (2) year warranty expiration. There will also be a five (5) year inspection set up for all LED fixtures to ensure that the City can keep ahead of maintenance issues to give the City's customers the best quality of service possible.

The Public Works Department intends to migrate the streetlight data into the Department's asset management system (IPS) in FY24. The Public Works Department is also developing a data QC program which will be completed by staff, staff on light duty assignments, and potentially interns. By developing a robust QC program, multiple staff will be able to assist with this data clean up project simultaneously. It will likely take several years to QC all areas of the City.

Direct Bury Poles

Historically, the City allowed direct bury poles to be installed. The direct bury poles are not attached to a base but embedded in the ground without any anchoring. The City does not allow this type of pole today. The City requires poles to be anchored to concrete base footings. Over time, these direct bury poles can shift due to settling and weather-related movement which increases the chances of the pole potentially tipping over.

As these poles are found, they need to be analyzed for safety and potentially prioritized for replacement. This is a cost that is not currently accounted for. Additionally, the City also does not have a full count of how many or where these poles are located in the City. Identifying these poles is listed as a goal in the Streetlight Program's 5-year Work Plan.

Colocations

Currently, the City has colocation agreements with Intermountain Gas Company as well as the City's Water Division and Police Department for co-locates on various streetlight poles.

A new challenge has developed with ACHD owned poles. The signal poles throughout the City are owned by ACHD while the light fixtures are owned by the City. ACHD has agreements with multiple entities to have 5G antennas on these signal poles. The City is in the process of trying to identify these locations. For safety reasons, maintenance cannot be performed on City fixtures adjacent to 5G antennas until the antennas are turned off. These antennas are comprised of hazardous components that, when energized,

are dangerous to work near. Unidentified 5G antennas result in the maintenance contractor visiting a site multiple times to make repairs, increasing costs and reducing efficiency. Identifying the locations of these co-located utilities will enable the City to keep its database up-to-date and minimize maintenance costs.

Appendix A – Streetlight Characteristics/Considerations/Types

Streetlight Characteristics

There are a multitude of lighting topics that must be understood and addressed when dealing with a comprehensive streetlight program.

Appendix A contains a comprehensive review of various systemwide characteristics that have been evaluated and included in developing the system's goals and standards.

Reviewing Appendix A may be helpful if the reader is interested in learning about some of the technical components of street lighting such as pole types, lighting types, and how Public Works balances competing street lighting needs (safety versus nuisance).

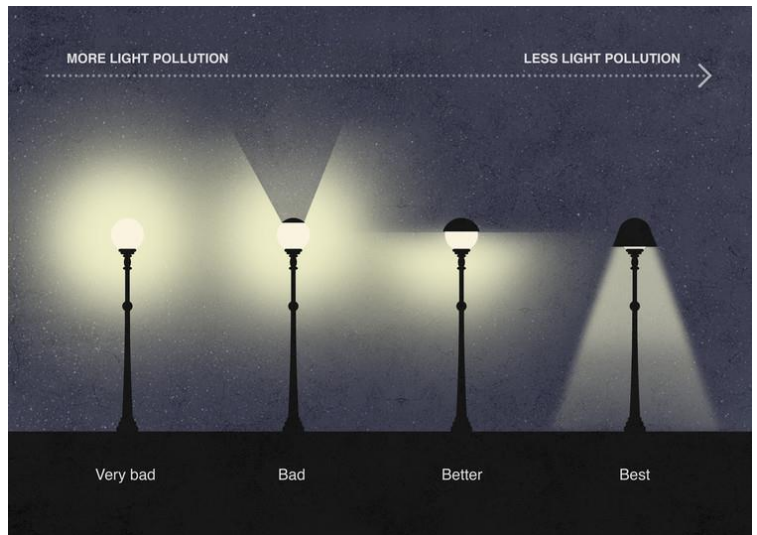

Systemwide Considerations

Appropriate Light Levels

Appropriate light levels vary based on roadway classification, adjacent land use, pedestrian activity, and proximity to open space. The City is working to upgrade lighting to appropriate light levels based on locations with the greatest need (underserved areas).

Appropriate light levels are balanced with environmental responsibility. In environmentally sensitive areas, lower light levels are desired.

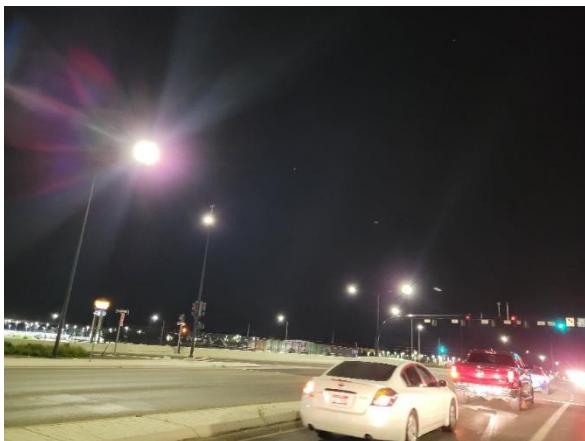

Appropriate Light Levels: This photo demonstrates appropriate light levels for a commercial area with medium to high pedestrian usage, where moderate light levels provide excellent visibility throughout the public streets and sidewalks.

Glare Reduction

Glare is caused by excessive or undesirable light entering the eye from a bright light source. Glare can result in discomfort, annoyance, and decreased visibility. There is the potential for direct glare when a light source is in direct view. The presence of direct glare depends on the intensity of the light source and contrast with the surrounding environment. With direct glare, the eye has a harder time seeing contrast and details. A lighting system designed solely on lighting levels aims more light at higher viewing angles, thus producing more potential for glare. Direct glare can be minimized with careful equipment selection as well as placement.

Reducing glare:

- Improves visibility on the roadways
- Creates a more enjoyable nighttime environment
- Reduces sky glow and light trespass, minimizing the obtrusive effects of light



Lights that create glare can result in a range of negative effects for drivers, pedestrians, and residents, ranging from annoyance to reduced visibility, and may generate complaints from residents.

Lights with low glare provide more comfortable streets and public spaces, providing light where it is needed without annoying nearby residents.



Uniformity Vs. Contrast

Lighting uniformity refers to the evenness of light. Our eyes are continually adapting to the brightest object in our field of view. For roadway lighting, good uniformity indicates evenly lighted pavement. However, good visibility requires the contrast of an object against the background. An environment with perfectly uniform lighting provides low contrast, which can reduce visibility. To create enough contrast for good visibility, there should be a balance between uniform perception and having enough contrast to improve visual detection of objects on the road. Uniformity criteria are typically described as ratios of maximum to minimum and average to minimum luminance or illuminance. Contrast is the difference between two adjacent luminance values. High contrast is necessary for good visibility.

Adaptation

Adaptation refers to the eye's ability to adjust between changes in luminance. One's eye will automatically adjust to the brightest object in its field of view. Glare from headlights or fixed lighting can affect one's ability to adapt to lower surface luminance. This is especially true as one ages. Another form of adaptation occurs when driving from a brightly lighted area to a non-lighted section of roadway.

Here, the lighted area should slowly transition to darker to allow adaptation time. Off roadway brightness, such as driving past a brightly lighted gas station or LED sign, can also cause adaptation issues. While this Master Plan does not directly address lighting on private property, it is intended to set an example for future lighting guidelines that could apply these lighting strategies to all exterior lighting in City of Meridian.

When street lighting and adjacent private lighting is designed to appropriate light levels, the eye can maintain a proper degree of adaptation. When the eye is adapted to the existing light, it is more effective at detecting and identifying objects, increasing safety.

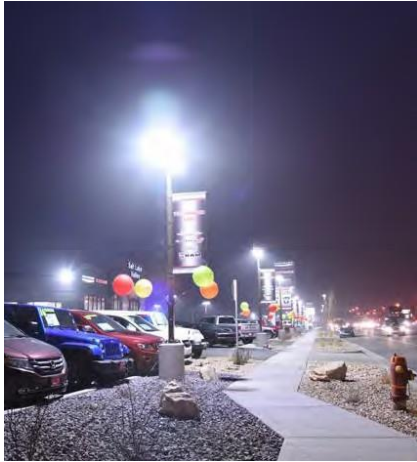

The privately-owned lighting at this auto dealership (left) is too bright and lacks proper shielding creating high adaptation issues transitioning from the sales lot to the street.

When roadways are illuminated to appropriate light levels (right) with good control of light, the eye is able to adapt, increasing visibility and safety on the streets.

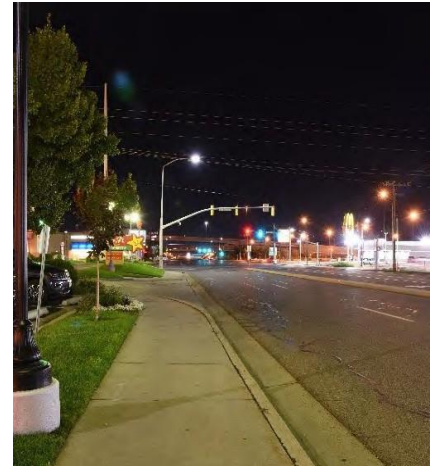

Color Rendering and Nighttime Visibility

The Color Rendering Index (CRI) is the standard metric used to evaluate how well a light source renders the true color of an object. CRI is measured on a scale of 0 to 100, with 100 representing how an object would look under a reference incandescent light source. The higher the number, the better the color rendering capacity.

Traditional High-Pressure Sodium (“HPS”) streetlights have a very low CRI of approximately 30, making color detection difficult. Today’s standard LED streetlights are not only significantly more energy efficient, they also have a much higher CRI, typically 65 or higher, increasing color detection, visual acuity, and overall effectiveness of the streetlights. LED lighting technology advancements allow streetlights to be tuned to a specific correlated color temperature (CCT) without drastically reducing the CRI. This technology can be used to reduce the color temperature in environmentally sensitive areas without significantly reducing the CRI, preserving the effectiveness of the lighting system.

LEDs emit light across the visual spectrum, considered white light, which appears brighter at night. When traditional HPS lights are replaced with LEDs, similar light levels often appear to be much brighter with LED lights. Residents may find the light to be obtrusive. When upgrading to LEDs in residential areas, the ability to have a dimming system to respond to complaints from residents may be explored.

Using a higher CRI improves safety by increasing visual acuity and object detection, making the roads safer for vehicles and pedestrians. Higher CRI improves character in the area by enhancing colors of landscaping and objects within the streetscape.



This car is illuminated by two different light sources. On the left, an LED light, with high color rendering, clearly reveals the color and details of the car. On the right, a low-pressure sodium light, with low color rendering, distorts the color of the car and details of the vehicle are not clear.

Color Temperature and Nighttime Visibility

Appropriate Correlated Color Temperature (CCT) of streetlights is largely depends on the location of the lights within the City. The City of Meridian consists of diverse land uses, ranging from high density urban areas to environmentally sensitive lowlands and foothills. Street type and adjacent land use determine the appropriate color of light.



In the distance, the warm amber glow of low CCT (1800K) high pressure sodium streetlights is shown in comparison to higher CCT (4000K) LED streetlights in the foreground.

Excessive Light Trespass

Excessive light trespass is defined as stray light that crosses a property boundary. The most obtrusive form of light trespass is often caused by an excessively bright luminaire that is unshielded and distributes light into adjacent property. Uncontrolled, non-shielded light sources can be the cause of light trespass. However, even a controlled, fully shielded luminaire may cause light trespass if not properly located or oriented. In cases where the location of a light standard cannot be changed, additional shielding may be necessary to prevent light trespass. Although designers should always strive to minimize light trespass, sometimes higher levels may be acceptable in downtown, commercial, and areas adjacent to civic land uses.



A pedestrian light with inappropriate light distribution and poor shielding creates a significant amount of light trespass on a nearby residence (left).

A well shielded streetlight with appropriate light distribution provides adequate light for the street and sidewalk with minimal light spill beyond the sidewalk (right).

Light Pollution

Light pollution and sky glow are caused by light aimed directly up into the sky and by light reflected from the ground or objects. Any additional light will add to light pollution. However, it is the direct uplight component that does not contribute to useful street level visibility and is the most objectionable form of pollution. Unshielded luminaires are major contributors to sky glow. Over lighting, even with fully shielded luminaires, reflects unnecessary light into the atmosphere and adds to sky glow. Street and pedestrian lighting in residential areas could be dimmable with additional technologies and shielding options are available to allow the City to address specific complaints about light pollution or light trespass.

Standardization

Standardization is an important consideration in what the City allows. Limiting options can reduce inventory and improve the speed in which the City can respond to maintenance and operations issues. Following are some of the factors used:

- Luminaire Styles
- Pole Styles
- Armature Styles
- Base Styles
- Color Options

Types/Brands of Poles

The City continues to evaluate new pole manufacturers and allow new poles that meet the City's structural and visual needs. The following manufacturers are accepted with the City: Northwest Signal Supply, KW, Valmont, Nova Pole, Lithonia Lighting, US Architectural, and Holophane.

- ACHD and ITD may install streetlights not listed in City standards. For example, ITD required break away bolts on the footing foundations. ITD also requires a substantially taller pole for streetlights, as does ACHD. The City does not require these pole heights because the maximum spacing allowed for City streetlights does not warrant the drastic price increase of these taller poles.

TYPE 1

- Over 30' in height
- Will have a mast arm between 8' and 15'
- Typically found on arterial and major collector roads
- All new ones should be black; may have some that will be silver
- High strength, low alloy, steel manufacturing ASTM (American Society for Testing and Materials) 572 Gr 50 or higher
- Fixtures are from the City of Meridian Approved LED Fixture List



TYPE 2

- 25' in height
- Typically, no mast arm
- Typically found in residential neighborhoods
- Fixtures shall be bronze or dark bronze and from the City of Meridian Approved LED Fixture List
- Poles shall be 4" squared, not tapered, 11-gauge steel



DECORATIVE STREETLIGHTS

- There are two types of decorative streetlights: City-owned and HOA-owned
- City does not own HOA decorative lights but the City does pay for power
- HOA decorative lights are not numbered



UTILITY POLES

- Typically mounted to an Idaho Power pole
- Owned and maintained by Idaho Power. City is billed for power use.
- In 2021, Idaho Power started converting to LED
- **No longer approved for installations**



SIGNAL

- Generally mounted to a traffic signal or pedestrian crossing. Fixtures are typically installed by ACHD.
- Fixtures and poles are generally black per ACHD standards
- Height varies between 30-40'



DAVIT POLES

- Used in place of a Type 1 streetlight when there are potential conflicts with overhead power
- Fixtures shall be black Type 1 approved fixtures
- High strength, low alloy, steel manufacturing ASTM (American Society of Testing and Materials) 572 Gr 50 or higher



Types/Brands of Lights

The City continues to monitor advances in streetlight technology to allow new technology and components that fit within the Streetlight standards and provide cost savings. Parameters that the fixtures must meet were set for the specific street lighting areas. This allows the developer/contractor to select an approved manufacturer and find the most cost-effective fixture that meets the City's needs within the provided parameters. As the technology progresses, the City will increase the "watts per lumen" requirements to ensure that the City is receiving the most efficient cost saving fixtures.

Currently, the City accepts the following light manufacturers: American Electric, Cooper/Streetworks, Leotek, and Lumec.

All City approved fixtures were required to be LED effective June 1, 2016.

Spacing

As streetlight technology advances, the City will re-evaluate the general spacing requirements to meet the latest standards and best practices. Streetlight spacing is based on an illumination plan and chart that is provided by the manufacturers to show the proper separation per brand and type of light. Examples are shown below for Type 2 and Type 3 roadways.

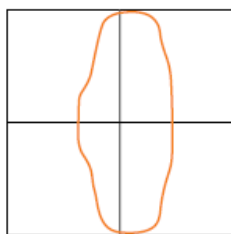

Type 2

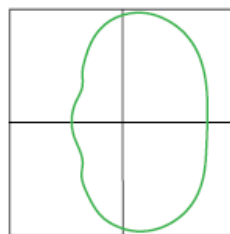

Type 3

Ownership and Pole Identification

- All City owned and maintained streetlights shall have numbers on the pole.
- Letters at the end of the number help to identify the billing schedule and maintenance schedule used for streetlights:
 - Ending in “A” – typically on an Idaho Power pole
 - Lights are owned and maintained by Idaho Power and the City pays for the power usage.
 - As the City increases the appropriate streetlights for the areas that contain these lights, these lights are typically removed as Idaho Power does not want to own City streetlights. Since Idaho Power doesn’t typically upgrade these lights to LED fixtures the City pays a higher power usage rate.
 - Ending in “B” – City-owned streetlight with some Idaho Power maintenance (lights and photocells)
 - NOTE: This fee schedule is ending in September 2023. At that time, all remaining “B” lights will be converted to Schedule 41C.
 - Idaho Power replaces the bulbs in the “B” lights on a 5-year rotation. They are currently on their last rotation and every light they change the bulb on, they transfer ownership to the City and these lights become “C”.
 - The initiative to transfer all of these lights was started in 2020 and the implementation of the transfer began in 2021.
 - Ending in “C” – City-owned and maintained streetlight
 - Majority of new lights will end in “C”. By the end of FY2023, all the streetlights in the City will either be an “A”, “C”, or “CM” billing schedule.
 - Ending in “CM” – billing schedule is for streetlights on major roadways
 - These streetlights are attached to a meter from which Idaho Power reads the kilowatt hour usage and bills the City accordingly.
 - All non-metered “C” scheduled lights are billed at a set rate depending on the fixture wattage of the streetlights.
- City will only maintain lights on public streets. Private road streetlights are the responsibility of the owner’s association (private roads have blue signs.) The City does pay the power bill for these lights, but does not pay for maintenance or replacement.
 - **NOTE:** This practice will be investigated in the future to determine if the City should be paying for power for these lights.

Appendix B – New Streetlight Installation Process



New Installation Process

Following the City standards that have been updated every year since 2010, developers are required to add street lighting on all public roadways in the developed properties.

Streetlight plans are submitted to the City through its online application system. Once approved by the City's Transportation and Utility Coordinator, the developer's Public Works licensed electrical contractor will open a streetlight permit. The contractor will begin the streetlight installation where they will call in an inspection for their rough-in electrical and foundations. Once this inspection is complete, the contractor will complete the streetlight installation. Idaho Power is notified for final connections to the existing power supply and the contractor requests their final electrical inspection from the City. Once this inspection is passed, the contractor will submit record drawings with the locations of the streetlights, underground power, type of light fixture, and available fault current at all splice locations. The fault current is so the City knows how many future streetlights can be added to the power source if needed.

Once the record drawings are approved, the Transportation and Utility Coordinator will send the drawings and an activation request letter to Idaho Power notifying them to transfer the power bill to the City. At that time, the Transportation and Utility Coordinator will close the permit and the City's GIS database will be updated with the information from the record drawings including the activation date and warranty expiration date.

New Lights in GIS

The City has the following process for new lights to be entered into the GIS database. The Public Works Inspectors GPS the streetlights gathering as much information as they can find in the field. Currently the information put in the system from GPS is Light Type, Pole Type, Pole Height, Mast Arm Length. Other

information such as wattage and bulb type should also be collected, although it is not always documented.

When the City approves the as built drawings from the electrical contractor, the Transportation and Utility Coordinator will fill out an activation request letter and send it to Idaho Power, Accounts Payable, and PW Support along with the as built drawings. At that time, the remainder of the fields can be filled out with the activation date and warranty information.

Once Idaho Power notifies the City that the streetlights have been transferred to the City, Idaho Power provides the City with the contract number for billing. At that time, the contract number will be put in GIS and then the Master Streetlight Tracking spreadsheet.

Once the Streetlight Program is integrated with the City's asset management database, the contract number will automatically transfer from GIS and duplicate entry will be eliminated.

Warranty Process

The warranty process begins with the approved record drawings. The record drawings require that the LED fixture information is provided which includes the manufacturer and model number. This allows the City to verify the 10-year factory warranty (all approved manufacturers for the City have 10-year factory warranties). GIS updates the City's GIS database with the activation date and two-year warranty date along with the installation contractor.

Future Install Agreements

Future install and reimbursement agreements are used when the City has knowledge of an ACHD or ITD road widening project that is planned to happen in the next three (3) years.

If a development is going in prior to a road widening project that will take place within three (3) years, the City collects the funds from the developer to cover their share of the cost of how many streetlights they would be responsible to install with their project. The City then uses those funds at the time of the widening project to pay for the streetlights.

Additionally, the City utilizes this approach on ITD owned roads because ITD only allows streetlights to be installed at a minimum one (1) mile stretch at a time. The City collects the money from the developments going in until there is enough lights/funds for that mile stretch.

See **Appendix E** for an example of a Future Install Agreement.

Reimbursement Agreements

Another mechanism to collect installation funding is in the form of a reimbursement agreement. In this case, if a roadway is widened before developments occur, the City may pay for the streetlights upfront. As development comes in, the developer reimburses the City for the cost of the required streetlights for their development.

Both types of agreements must be tracked and monitored over time.

Appendix C – City of Meridian Street Lighting Specifications

Streetlight Program Guidelines

Detailed street lighting guidelines and requirements are established in the Meridian Design Standards and Supplemental Specifications. Generalized programmatic guideline statements are included below.

City of Meridian lighting standards are based on IES and AASHTO recommendations with allowances for adaptive standards that encourage dimming strategies relating to pedestrian activity, community engagement, wildlife.
Lighting level and design will be upgraded to current standards as lights are replaced and new lights are installed.
All newly installed streetlight electrical lines shall be underground.
When practical, installation of underground conduit for streetlight electrical lines shall be included in road reconstruction projects.
Only dedicated publicly-owned streets are eligible for street lighting funded by the City.
Placement of streetlight poles shall meet safety standards including lateral clearance requirements.
Energy efficient lights shall be used for new and replacement lighting.
Install new street lighting within a minimum standard.
Residential neighborhoods may adopt a decorative streetlight fixture and retain ownership of those fixtures. The City will pay the power on those fixtures, but not maintain the fixtures.
All new and replacement lighting shall be from the approved list developed by the City's Engineering Division.
It is the practice of the City of Meridian's Engineering Division to support crime prevention efforts in the design and operation of street lighting within City of Meridian.
It is the practice of the City of Meridian's Engineering Division to support the use of banners on streetlight poles to enhance a sense of community and contribute to traffic calming where appropriate.
The City's intent is to have pedestrian decorative scale lights (typically 12' to 15' mounting height) on streets where street lighting alone does not effectively illuminate the sidewalk due to shadowing from trees, or the location of the sidewalk in relation to the street.

Design Standards and Specifications

In 2010, the City began using the Association of State Highway and Transportation Officials (AASHTO) and Illuminating Engineering Society (IES) to develop design standards in order to create a uniform direction for the City’s streetlights.

These standards are reviewed at least annually and are updated regularly to address new products and technologies.

Current (2023) City street lighting design standards/specifications can be found in **Appendices C and D**.

DIVISION 1100
TRAFFIC

SECTION 1101
TRAFFIC SIGNALS AND APPURTENANCES

PART 1 GENERAL

 1.4 SUBMITTALS

 E. Submit warranty for all supplied material and workmanship for a period of two years from final acceptance. The warranty must state that the products supplied were free of defects and suitable for the uses set forth in the specifications.

●● END OF SECTION ●●

TRAFFIC Page 1 of 7 SECTION 1101

SECTION 1102**STREET LIGHTING****GENERAL INFORMATION**

These specifications are for street lighting that is to be dedicated to the public and maintained by the City of Meridian. Such installations require a street lighting electrical permit to be opened prior to beginning work; street lighting shall not be included in a building general electrical permit. Permits can be pulled online through the City's Citizen Access Portal.

Conduit and foundation reinforcement must be inspected prior to backfill and pouring of concrete. Request inspections through the online Streetlight Permit, 48 hour notice required. The City will not authorize Idaho Power to connect street lighting until the electrical permit is final and any other requirements are met.

PART 1 GENERAL**1.4 SUBMITTALS**

- D. Submit warranty for all supplied materials and workmanship for a period of two years from final acceptance. The warranty must state that the products supplied were free of defects and suitable for the uses set forth in the Specifications.

1.5 PROJECT RECORD DOCUMENTS

- A. Provide the following information on a copy of the street light plan:
 1. Accurately and neatly record locations of constructed street lights, conduit runs, junction boxes, and service points.
 2. Record the Model and Wattage of the fixtures installed.
 3. Label the available fault current of each service point.
- B. Upload a copy of the streetlight plan with the above field notes to the street light permit on the City's citizen portal, or deliver a hard copy to the City Transportation and Utility Coordinator prior to requesting final inspection.

PART 2 MATERIALS**2.2 JUNCTION BOXES**

- A. Junction boxes located in sidewalks or areas subject to vehicular traffic shall be high density reinforced precast concrete or fibrelyte type N09 or approved equal with reinforced concrete bolt-down lid marked "ELECTRICAL" or "STREET LIGHTING."

DIVISION 1100
TRAFFIC

2.4 CONDUCTOR

- C. Overhead connection of street lights is not allowed except in unusual circumstances approved by the City Engineer.

2.5 CONDUIT

- A. Above ground conduit runs are not allowed in City of Meridian installations.

2.6 PHOTCELLS

- C. Photocells used for LED fixtures have a design life of 20 years and a 10 year manufacture warranty. If a fixture is to be controlled by a central photocell in a meter pedestal install a shorting cap in the photocell receptacle.

2.8 MAST ARMS FOR WOOD POLES

- A. Wood poles are not allowed in City of Meridian installations.

2.9 WOOD POLES

- A. Wood poles are not allowed in City of Meridian installations.

2.10 METAL POLES

- B. Poles for Type 1 street lights shall be high strength low alloy steel meeting ASTM 572 Gr 50 or higher. Unless otherwise specified, exterior surfaces are to be coated with a Polyester Powder to a minimum dry thickness of 2.0 mils. The pole and mast arm manufacturer shall guarantee exterior surface color coating adhesion for a minimum of 5 years. **Color of finish topcoat will be semi-gloss black.** Galvanized poles coatings shall meet ASTM A-123.

Poles shall conform to City of Meridian Standard Drawing T1. In cases of conflict with overhead wiring, a davit style version of Type 1 street light poles may be approved as shown in City of Meridian Standard Drawing T4. Poles shall be supplied with a two-piece steel full base cover.

1. Approved Type 1 Pole Manufacturers:
Northwest Signal Supply, KW, or Valmont
2. Approved Davit Pole Manufacturers:
Valmont, or KW

●● CONTINUED ON NEXT PAGE ●●

DIVISION 1100
TRAFFIC

Poles for Type 2 lights shall be 4 inches square, non-tapered, with 11 gauge steel and coated with dark bronze corrosion resistant polyester powder coating. Mounting holes for fixture shall be pre-drilled for any unused holes plugged. Mounting height shall be 25 feet. Poles shall be supplied with a two-piece steel full base cover painted to match pole. See City of Meridian Standard Drawing T2 for additional details.

1. Approved Type 2 Pole Manufacturers:
KW, Lithonia Lighting, US Architectural, or Valmont
- C. Pole installation to be with concrete base per paragraph 2.14 and City of Meridian Standard Drawing T2.
- F. Poles shall be labeled with assigned pole numbers shown on the plans. Labels shall have 2" tall white numbers/letters on black background. Labels shall be affixed to poles approximately 5-6' above grade, on the street side of the pole, with the labels placed vertically so that the first number of the pole ID is at the top.

2.12 HISTORICAL POLES (Decorative)

- A. Historical (Decorative) poles used in the City of Meridian's downtown urban renewal area shall be heavy wall, cast aluminum produced from certified ASTM 356.1 ingot per ASTM B179-95a or ASTM B26-95. The castings shall be formed true to the pattern with complete detail. All hardware shall be tamper resistant stainless steel. Anchor bolts to be completely hot dipped galvanized. Poles shall be:
 1. Black in color
 2. Model Holophane CP12F5/18-CA/BK, see City of Meridian Standard Drawing T7.
 3. Designed to accept Holophane head, model ARU-70-4K-AS-G3-B-S or approved equal
 4. Installed with Holophane cast aluminum banner arms BA24H/1/BO or BA24H/1.5/BO, or approved equal, at the request of City of Meridian
 5. Installed with Holophane weatherproof receptacle with GRCI, part no. FG-SXXH, or approved equal, at request of City. Receptacle cover shall meet the requirements of the NEC for outdoor and "in-use" type.

●● CONTINUED ON NEXT PAGE ●●

DIVISION 1100
TRAFFIC

- B. Pole installation to be with concrete base per paragraph 2.14 and per City of Meridian Standard Drawing T2.

2.13 CONCRETE POLE BASES

- D. Base dimensions and construction shall conform to City of Meridian Standard Drawing T2.
- E. All street light foundations shall be located such that no existing conduit, pipe or other underground utility facility conflicts with the entire volume of the pole foundation. If a conflict with an existing street light conduit or an existing traffic signal conduit exists, the Contractor shall relocate the existing conduit out of the area of conflict. If a potential conflict with any underground utility facility other than street light or traffic signal conduit exists, the Contractor shall bring the potential conflict to the attention of the City. Conformance with these provisions as required to complete the Work, including relocation of existing street light and/or traffic signal conduits, shall be considered incidental to and included in the payment for street light installation and no additional compensation will be made.

2.14 PREFABRICATED BASES

- A. Prefabricated bases are not allowed in City of Meridian installations.

2.15 SERVICE PEDESTAL

- A. External construction shall be 1/8" thick steel and hot dipped galvanized per ASTM A312. Internal parts shall be constructed of 14 gauge cold rolled steel. Construction shall be fully welded. All fasteners, latches and hardware shall be stainless steel with no exposed nuts, bolts, screws, or other fasteners exposed on the exterior. Cabinets have 2,000 lb street-rated padlock hasps welded to the cabinet and door. Outer doors have closed-cell Neoprene flange. See City of Meridian Standard Drawing T5.
- B. Provide and install one Master-lock padlock on each padlock hasp – model shall be 1KA; contact Meridian Public Works for the master key number. All keys must be given to the Meridian Public Works Department electrical inspector before the electrical permit will be finalized.
- C. All service pedestals shall be equipped with photo control with a viewing window – as a result, any lighting connected to a service pedestal shall have shorting caps and not individual photo controls located on the luminaires.

DIVISION 1100
TRAFFIC

2.16 LIGHT FIXTURES

- A. Light fixtures shall be LED fixtures as described in the City of Meridian Approved Fixture List.

Delete Paragraphs B, C, D, E, F, and G.

2.17 SPLICE BOXES

- A. When a splice is required use SEC Model 0791-0 Splice Kit, Polaris SSB 2/0, or approved equal – wire nuts shall not be used on the hot or neutral wires.

PART 3 WORKMANSHIP

3.1 EXAMINATIONS

- A. Verify the pole excavation location and depth matches the approved plans and specifications, prior to installation of the pole. See Standard Drawings T2 and T8.

3.2 JUNCTION BOX INSTALLATION

- A. Install as required by City of Meridian Standard Drawing T3 and to locations as shown on the plans. Junction box spacing shall never exceed 400 feet along straight conduit runs, and shall be installed at any sharp bends, wire splices, or where conduit junctions occur.
- D. Junction boxes shall not be installed in driveways or roadways except in unusual circumstances approved by the City Engineer.

3.3 WIRE OR CONDUCTORS

- A. See section 2.18 for approved splice connectors.
- E. Overhead connection of street lights are not be allowed.
- F. See City of Meridian Standard Drawing T3 for wiring details and allowed system voltages.

3.6 DISCONNECT BOXES

- A. Disconnect boxes are not allowed in City of Meridian installations.

DIVISION 1100
TRAFFIC

3.7 GROUNDING

- A. Attach pole ground to rebar cage by means of NEC code approved grounding connector. See City of Meridian Standard Drawing T3.

3.8 CONCRETE POLE BASES

- A. Base installation and dimensions shall conform to City of Meridian Standard Drawing T2.

3.9 POLE INSTALLATION

- B. Pole installations shall conform to City of Meridian Standard Drawing T2 and T3.
- C. Historical poles to be installed in accordance with City of Meridian Standard Drawings T2 and T3.
- D. All poles shall be installed under the power company required clearances shown on Standard Drawing SD-1122 and under the requirements of the City Of Meridian Standard Drawing T8.
- G. Direct burial poles are not allowed in City of Meridian installations.

3.11 SERVICE PEDESTAL

- A. Due to the metering requirements of Idaho Power, metered service pedestals are required for all Type 1 (including Davit pole) street lighting systems. Service pedestals and associated wiring shall be installed per City of Meridian Standard Drawings T5 and T6.

●● END OF SECTION ●●

Appendix D – City of Meridian Street Lighting Design Standards

[31]

SECTION 6 STREET LIGHTING

6-1 SECTION SUMMARY:

This section contains guidance and requirements for street lights and the development of street light plans. Guideline drawings are included at the end of the section. Please refer to the drawings as well as the section standards when designing development street lighting.

6-2 APPLICABLE STANDARDS:

The requirements listed below shall apply to the design of street lighting. Conflicts between these requirements shall be resolved on a case-by-case basis.

- A. All applicable standards as listed in Section 2-2
- B. ANSI/IES RP-8-14 Roadway Lighting
- C. AASHTO Roadway Lighting Design Guide

6-3 STREET LIGHTS REQUIRED:

Street lights will be required for all developments within the urban area, along all streets and pathways offered for dedication, including existing streets bordering the development unless exempted by Section 6-4 below. In addition, street lights may be required for lots and parcels containing existing structures which are being improved or altered, depending on the nature and extent of the work. Illustrations of street lights generally required are shown on Design Standards Drawing 6A.

6-4 STREET LIGHTS NOT REQUIRED:

Street lights will not be required under the following circumstances:

- A. For planned developments, residential, commercial, and industrial developments where internal streets are not offered for dedication, a street lighting system will not be required for the internal non-dedicated streets, but shall be provided by the developer on external public street frontage.
- B. In areas where site conditions preclude the installation of street lights adjacent to the development, the owner or developer will be required to deposit monies sufficient to design, install, and inspect street lights under the direction of the Meridian Public Works Department. These lights will be installed when site conditions adjacent to the development become more favorable or in alternate locations in the general vicinity of the development.

6-5 DEVELOPER'S RESPONSIBILITY:

- A. Existing street lights which must be relocated or repositioned as a result of the construction of new streets or driveways into a development are the responsibility of the developer to relocate.
- B. Any new services, including those with a step-down transformer, which are required as a result of the modification of an existing utility service pedestal, are the responsibility of the developer.

Section 6 – Street Lighting
March 2019 – Revised

- C. The developer is responsible to ensure that power remains to the existing street light system until the new street light system to replace it is complete and functioning correctly.
- D. The developer is responsible for all costs associated with creating a fully functional lighting system.
- E. The developer, or his legally authorized representative, is responsible for providing as-built record drawings of the street light installation as described in Section 1102 Part 1 of the Supplemental Specifications.

6-6 CERTIFICATES OF OCCUPANCY:

- A. Lack of a functional street lighting system at the time certificates of occupancy are requested shall be grounds for denial of such certificates.
- B. A finalized electrical permit, issued through the City of Meridian Building Division for street light system work, is required before the City will assume energy costs and authorize Idaho Power to energize the street light system.

6-7 PLAN DETAILS:

- A. Plans shall show and identify all street lights to be installed, all existing lights in the project vicinity and all applicable provisions and details specified in these standards.
- B. The street lighting plan should be included in the overall development plan set and shall be a stand-alone plan containing the following information:
 1. A vicinity map or equivalent
 2. Utility poles and public easements
 3. Names of adjacent subdivisions
 4. Names of streets
 5. Block and lot numbers if available
 6. Intersecting property lines of adjacent properties
 7. A "Symbols" legend conforming to Design Standards Drawing 6A
 8. A North arrow and appropriate scale (1"=10' to 1"=100')
 9. All existing street lights on both sides of any streets
 10. Street Lighting Standard Notes located on the City's website Land Development Services section; Standard Notes for Development Projects

6-8 DESIGN REQUIREMENTS:

Street lighting shall be designed in conformance with these standards and the current editions of the ISPWC and the City of Meridian Supplemental Specifications to the ISPWC. Average maintained illuminance or luminance levels, uniformity, and veiling luminance ratios shall be designed to meet the levels specified in the ANSI/IES RP-8-14 or the AASHTO Roadway Lighting Design Guide. Data and calculations verifying compliance of the above requirements shall be submitted for review, or the Design Standards included herein shall apply.

- A. Avoid excessive light trespass into neighboring residences. Utilize IES Type II distribution patterns and/or house-side shields where light trespass could be an issue.
- B. Coordinate street light locations on design plans to avoid conflicts with tree locations identified in the landscaping plans.

6-9 STREET LIGHT DESIGN DETAILS:

Design details for street lights are as follows:

- A. **Intersections** – Intersections shall have at least one street light; this includes large commercial driveways. Intersection street light locations and the number required shall conform to Design Standards Drawings 6D, 6E, and 6F.
- B. **Cul-de-sacs** – All cul-de-sacs shall have a street light within the ‘bulb,’ as shown in Design Standards Drawing 6E.
- C. **Micro-paths & Multi-use Pathways** – Street lights shall be placed at both ends of micro-paths and multiuse pathways. Bollard type lighting may be required along the length of the pathway per UDC 11-3A-8. In the case of properties abutting State Highway 55 (Eagle Rd), decorative pathway lighting may be required per UDC 11-3H-4C3.
- D. **Spacing** – Maximum street light spacing shall be measured along roadway centerline and shall conform to Design Standards Drawing 6C. Maximum spacing for downtown historical poles shall be 80 feet.
- E. **Street Light Poles** – The position of street light pole bases shall conform to the Supplemental Specifications. Poles located along State Highways, within the clear zone, shall have breakaway bolts.
 1. All Type 1 street light poles shall be round steel powder-coated black per the Supplemental Specifications, and conform to Supplemental Specifications Drawing T1 unless otherwise directed by the City of Meridian Transportation & Utility Coordinator.
 2. A davit pole may be approved by the City Engineer in place of Type 1 poles in instances of overhead utility line conflicts.
 3. All Type 2 street light poles shall be square steel with bronze polyester coating and conform to the Supplemental Specifications.
 4. Historical poles shall be used in the Downtown Meridian Redevelopment area and shall conform to the Supplemental Specifications.
- F. **Luminaires** – Luminaires shall be LED fixtures that are on the approved fixture list (see Design Standards Drawing 6C, note 2), or have been pre- approved in writing by the City’s Transportation and Utility Coordinator.
- G. **Service** – All street light systems shall have underground electrical services provided. Service voltage shall be 120 or 240 volts only.

1. The City Engineer or authorized representative may approve overhead service in unusual areas when justification is given why service cannot be provided underground.

- H. **Metering** – All lights on arterial and collector roads (except those fully contained within a subdivision) shall be metered per Idaho Power requirements. The meters shall be contained in a service pedestal conforming to Division 1100, section 1102 of the Supplemental Specifications.

Where a metered system is required, new developments shall install conduit with one No. 10 stranded pullwire from the last light on each end of the system to the adjacent property line on a stubbed street, where the adjacent property has no existing street light system. This will allow for the continuation of the street lights when the adjacent property is developed.

- I. **Installation of Non-Standard Street Lights** –

1. Where standard Type 2 lights are required, the City may approve the use of non-standard street lights (e.g. decorative street lights not specified in the City Standards) with a written agreement between the City and Developer, releasing the City from maintenance responsibility. The City will accept responsibility for the energy cost of these street lights. A sample agreement can be obtained from the Public Works Department.
2. When the use of non-standard street lights is approved by the City, the developer shall be required to submit design calculations for the pole spacing including photometric calculations and plots showing the design meets the minimum light levels and other criteria of these Design Standards. The City reserves the right to deny use of specific light pole models.

6-10 LAYOUT DESIGN PROCEDURE:

The purpose of the layout process is to establish an overall uniform street light system meeting minimum requirements. The design procedure for the street light layout is as follows:

- A. Identify the nearest control points (intersections, 90 degree bends in streets, large driveways, existing street lights) in each direction of travel from the street light locations being planned. Determine the location of the street lights at the control points in conformance with Section 6-9 above.
- B. Identify any existing street lights situated between the intersections.
- C. Determine the distance between control points on either end of the design area.
- D. Divide the distance into equal spaces between lights not to exceed the maximum spacing requirements specified in Section 6-9 above.

[35]

- E. Compare the light locations to intersecting property lines, driveways, micro-paths/pathways, and other obstructions as follows:
 - 1. If the location falls close to a property line and it can be adjusted to the property line within the maximum spacing allowed, then the adjustment should be made.
 - 2. Generally, street lights should be situated at lot corners for residential lots and parcels with minimal frontage (75 feet or less). The light spacing may have to be unbalanced, with additional lights being added, to attain this and still comply with the maximum spacing allowed.
 - 3. Street light locations shall be adjusted to miss driveways, existing utility poles, trees, and other obstructions by the clearances shown in Supplemental Specifications drawing T8.
- F. Where street light pole installations cannot be reasonably accommodated due to existing utility-owned poles with overhead electric power lines, the serving utility company should be contacted to determine if street lights can be installed on the existing poles.
- G. On all streets except for collectors with metered lights, lights should be staggered on either side of the road to create better uniformity (i.e. lights on one side of the road should be located approximately halfway between lights on the opposite side). In some cases the layout may need to be one-sided due to utility conflicts. If a single sided layout is required, it will be communicated to the designer during the pre-plat or Certificate of Zoning Compliance application process.
- H. The layout for collector streets with metered lights should be one-sided to reduce the amount of conduit, wire and service pedestals required.

STREETLIGHT MASTER PLAN

SYMBOLS

PROPOSED	EXISTING	
		TYPE 1 STREET LIGHT
		TYPE 2 STREET LIGHT
		JUNCTION BOX
		SERVICE POINT JUNCTION BOX
		CONDUIT
		SERVICE ENCLOSURE (CAN)
		U.G. UTILITY SERVICE
		TRANSFORMER
		UTILITY POLE

CITY OF MERIDIAN
PUBLIC WORKS DEPARTMENT

STREET LIGHTING
POLES & SYMBOLS

City Engineer
SCALE: NONE DWN: ANP
DATE: 7-1-2015 DWG: 6A

Section 6 – Street Lighting
March 2019 – Revised

STREET CLASSIFICATIONS

STREET	FROM - TO	PEDESTRIAN CLASS
AMITY	MCDERMOTT - CLOVERDALE	LOW
BLACK CAT	CHINDEN - LAKE HAZEL	LOW
CHERRY	MCDERMOTT - MERIDIAN	LOW
CHERRY/FAIRVIEW	LINDER - CLOVERDALE	MED
CHINDEN, 20/26	STAR - EAGLE	LOW
COLUMBIA	MERIDIAN - CLOVERDALE	LOW
EAGLE, SR55	MCMILLAN - OVERLAND	MED
EAGLE	OVERLAND - LAKE HAZEL	LOW
FRANKLIN	MCDERMOTT - CLOVERDALE	MED
LINDER	CHINDEN - COLUMBIA	LOW
LAKE HAZEL	MCDERMOTT - CLOVERDALE	LOW
LOCUST GROVE	CHINDEN - USTICK VICTORY - COLUMBIA	LOW
LOCUST GROVE	USTICK - VICTORY	LOW
MCDERMOTT	OVERLAND - LAKE HAZEL	LOW
MCMILLAN	STAR - LOCUST GROVE	LOW
MCMILLAN	LOCUST GROVE - EAGLE	LOW
MERIDIAN	CHINDEN - USTICK	LOW
MERIDIAN	USTICK - OVERLAND	MED
MERIDIAN, SR69	OVERLAND - COLUMBIA	LOW
OVERLAND	TEN MILE - CLOVERDALE	LOW
PINE	TEN MILE - LOCUST GROVE	MED
PINE	LOCUST GROVE - CLOVERDALE	MED
TEN MILE	CHINDEN - LAKE HAZEL	LOW
USTICK	STAR - CLOVERDALE	LOW
VICTORY	MCDERMOTT - CLOVERDALE	LOW

CITY OF MERIDIAN
PUBLIC WORKS DEPARTMENT

City Engineer
MERIDIAN STREET CLASSIFICATIONS

SCALE: NONE DWN: TKC
DATE: 2-16-2015 DWG: 6B

STREET WIDTH tbc-tbc	STREET LIGHT TYPE***	NOMINAL MOUNTING HEIGHT	STANDARD MAST ARM LENGTH	MAXIMUM SPACING* (Staggered)	MAXIMUM SPACING* (One Sided)
85-105 ft	1	35'	15'	250'	NA
65-84 ft	1	35'	12'	300'	200
45-64 ft	1	30'	8'	220'	220'
34-44 ft	2 or 1	25' or 30'	NA or 8'	220' or 270'	220' or 270'
33 ft or less	2	25	NA	260'	260'

NOTES:

1. USE ROADWAY WIDTHS AS PLANNED TEN YEARS FROM THE ANTICIPATED CONSTRUCTION DATE PER THE ACHD CAPITAL IMPROVEMENT PLAN
2. SEE APPROVED FIXTURE LIST ON THE LAND DEVELOPMENT SERVICES PAGE OF THE CITY WEBSITE FOR A LIST OF MODELS APPROVED FOR EACH ROADWAY CLASSIFICATION
3. LUMENS USED TO CALCULATE SPACING SHALL BE REDUCED BY A LIGHT LOSS FACTOR OF 0.86 FOR LED LAMPS AND 0.78 FOR OTHER LIGHT SOURCES
4. SPACING MAY BE ADJUSTED + 10% TO ALLOW FOR DRIVEWAYS

* SPACING ON ROADS 65 FT AND WIDER ACCOUNT FOR DISTANCE BETWEEN POLES ON ONE SIDE OF ROADWAY ONLY

** MAX SPACING FOR THE TWO MOUNTING HEIGHTS ARE LISTED RESPECTIVELY

*** SEE DRAWING 6A

City Engineer

CITY OF MERIDIAN PUBLIC WORKS DEPARTMENT	STREET LIGHTING DESIGN CRITERIA		SCALE: NONE	DWN: ANP
			DATE: 4-15-2016	DWG 6C

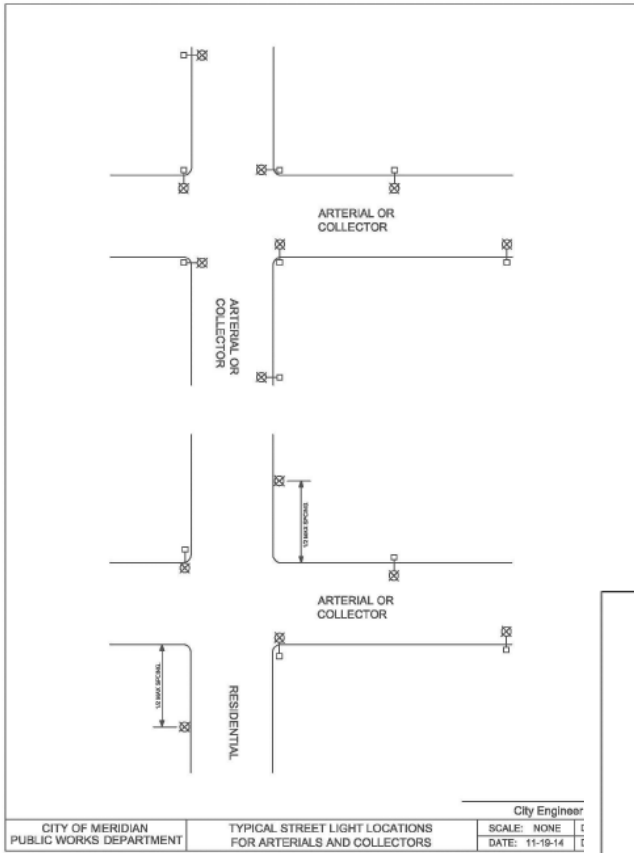

Section 6 – Street Lighting
March 2019 – Revised

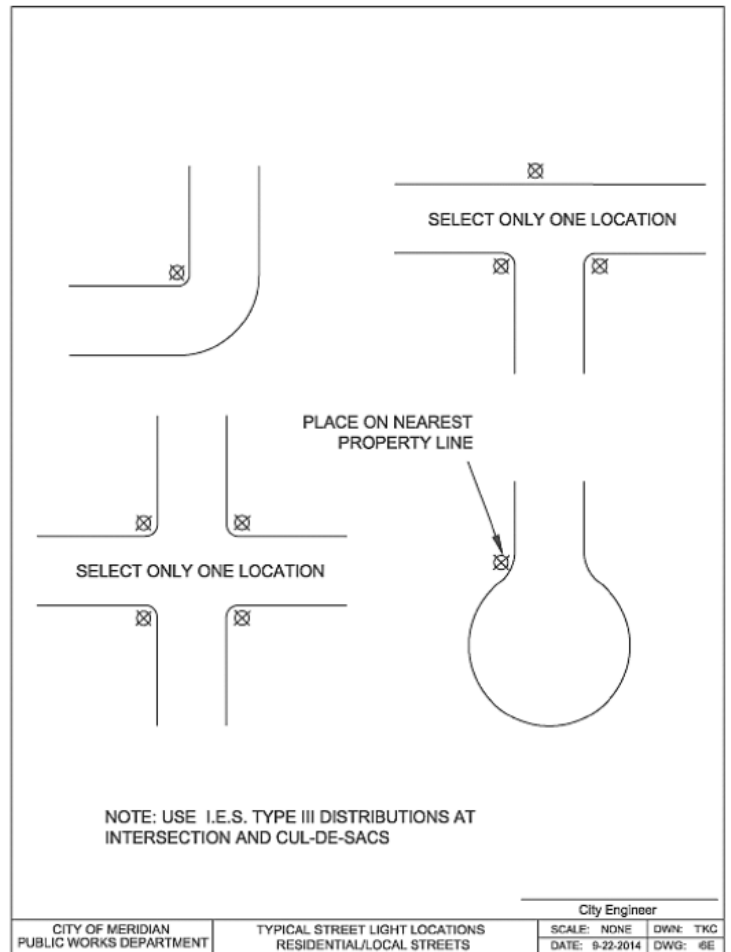

Section 6 – Street Lighting
March 2019 – Revised

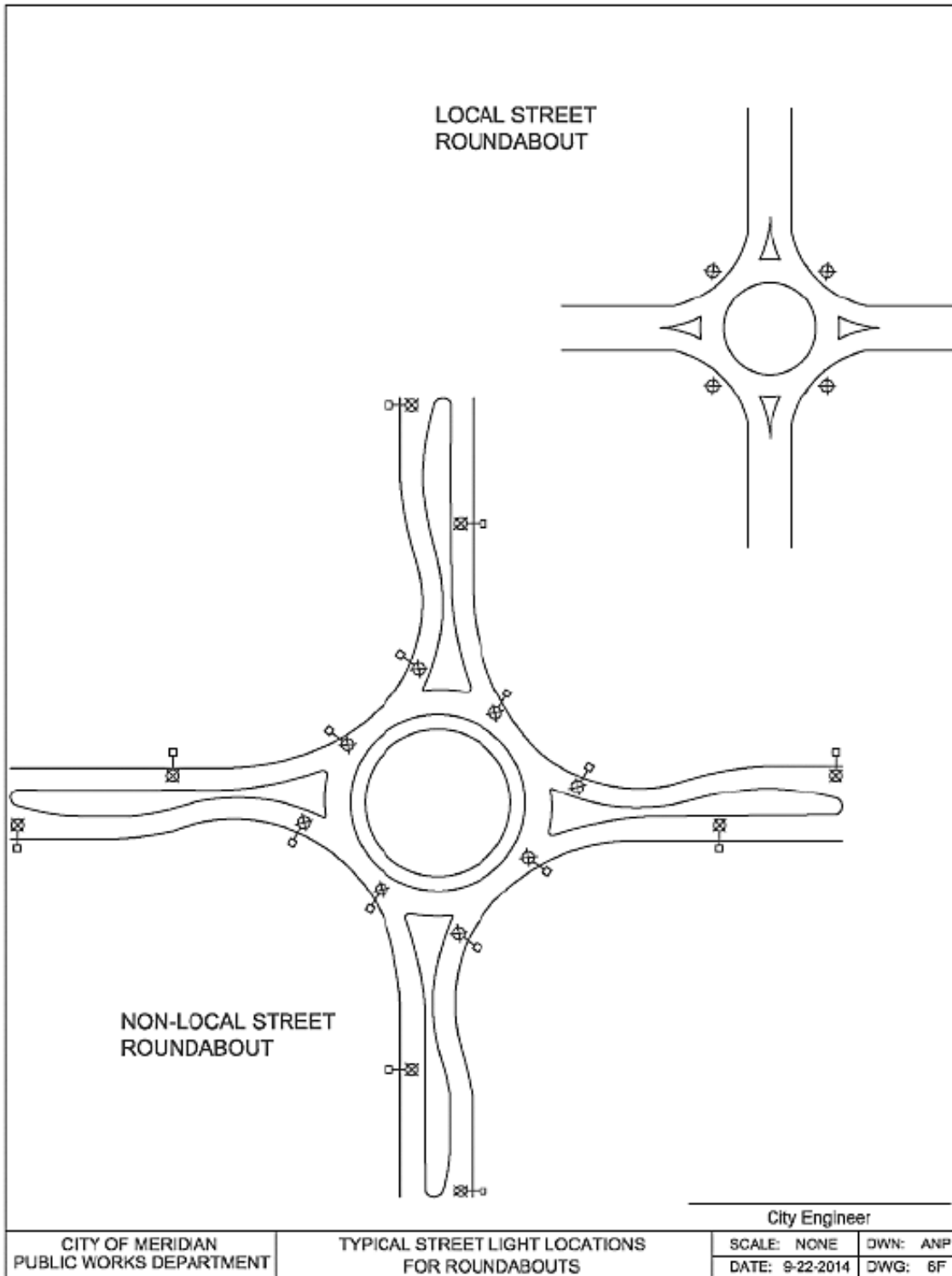

-END OF SECTION-

Section 6 – Street Lighting
March 2019 – Revised

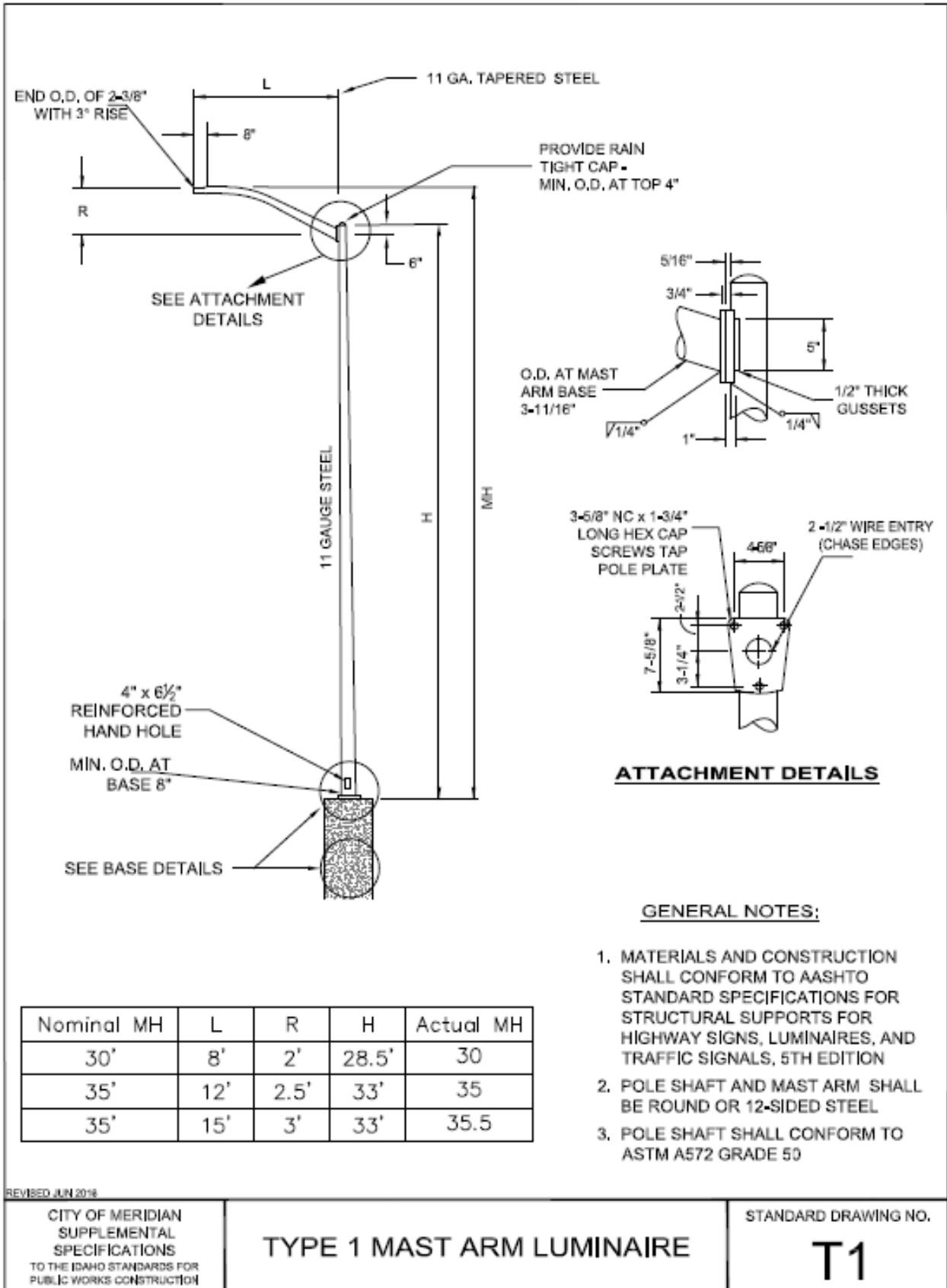

POLE TYPE	X	Y	D	E	W	HOOPS			RODS		
						NO.	SIZE	LIN. FT	NO.	SIZE	LIN. FT
TYPE 1 - 30'	24"	60"	10½"	11"	11½"	4	#4	21'	6	#4	36'
TYPE 1 - 35'	30"	84"	10½"	11"	11½"	6	#4	41'	6	#6	39'
TYPE 2	24"	60"	8"	9"	8"	4	#4	21'	6	#4	27'
HISTORICAL	24"	60"	12"	13"	N/A	4	#4	21'	6	#4	27'
DAVIT	24"	72"	10½"	11"	11½"	5	#4	31' 4"	8	#5	44'

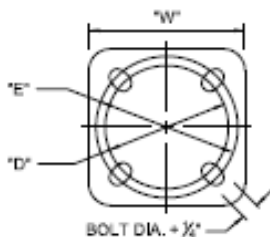
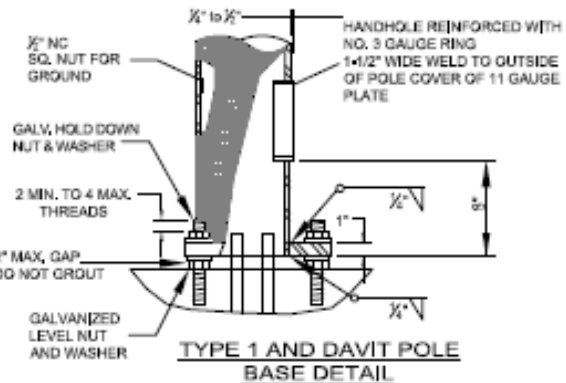
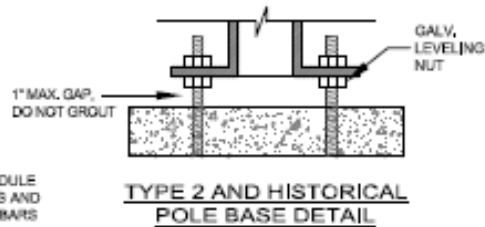
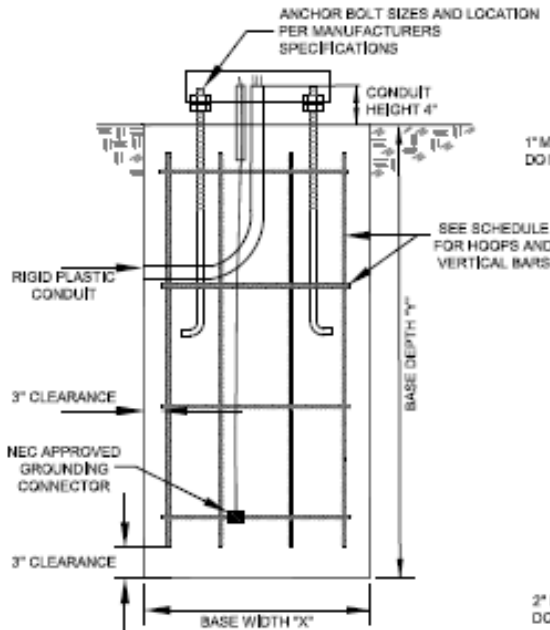

BASEPLATE AND BOLT PATTERN DETAIL

GENERAL NOTES:

1. CONCRETE FOR FOUNDATIONS SHALL HAVE A MINIMUM 28-DAY COMPRESSIVE STRENGTH OF 3,000 PSI.
2. ALL REBAR REINFORCEMENT SHALL HAVE 3" CLEARANCE FROM OUTSIDE OF CONCRETE FOUNDATION.
3. HOOP SHALL HAVE A 6" LAP LENGTH MINIMUM
4. BREAKAWAY BOLTS ARE REQUIRED WHEN ON STATE HIGHWAYS, SEE ITD STANDARD DRAWING I-7-C.
5. TYPE 1, TYPE 2 AND DAVIT POLE TO BE PROVIDED WITH METAL, 2-PIECE BASE COVER TO MATCH POLE FINISH
6. ALL CONDUIT ELBOWS USED IN CONCRETE BASES SHALL BE RPC
7. STEEL CONDUIT SHALL BE USED TO EXTEND ELBOWS BEYOND FOUNDATION
8. SPARE STUBOUTS SHALL BE TERMINATED WITH A STEEL COUPLING AND PLASTIC PUSH PLUG AT BOTH ENDS

REVISED JUL 2018

CITY OF MERIDIAN
SUPPLEMENTAL
SPECIFICATIONS
TO THE IDAHO STANDARDS FOR
PUBLIC WORKS CONSTRUCTION

**DETAILS FOR
STREET LIGHT BASE INSTALLATION**

STANDARD DRAWING NO.

T2



FUSED "IN-LINE" TYPE WIRE CONNECTOR
MODEL SEC 1791-SF OR APPROVED EQUAL

MINIMUM ALLOWABLE WIRE SIZES (AWG)*					
TYPE 1 CORRHEAD		TYPE 2 SHOEBOX		HISTORICAL	
VOLTAGE	AWG (MIN)	VOLTAGE	AWG (MIN)	VOLTAGE	AWG (MIN)
120	4	120	8	120	10
208	8	208	NOT ALLOWED	208	10
240	10	240	NOT ALLOWED	240	10
277	NOT ALLOWED	277	NOT ALLOWED	277	NOT ALLOWED
480	NOT ALLOWED	480	NOT ALLOWED	480	NOT ALLOWED

* MAX. RUN LENGTHS FROM SERVICE POINT TO FARTHEST STREET LIGHT BEING SERVED BY THE SYSTEM SHALL NOT EXCEED SPECIFIED DISTANCE
 * MAX. RUN LENGTH = 2500' * MAX. RUN LENGTH = 1500' * MAX. RUN LENGTH = 1000'

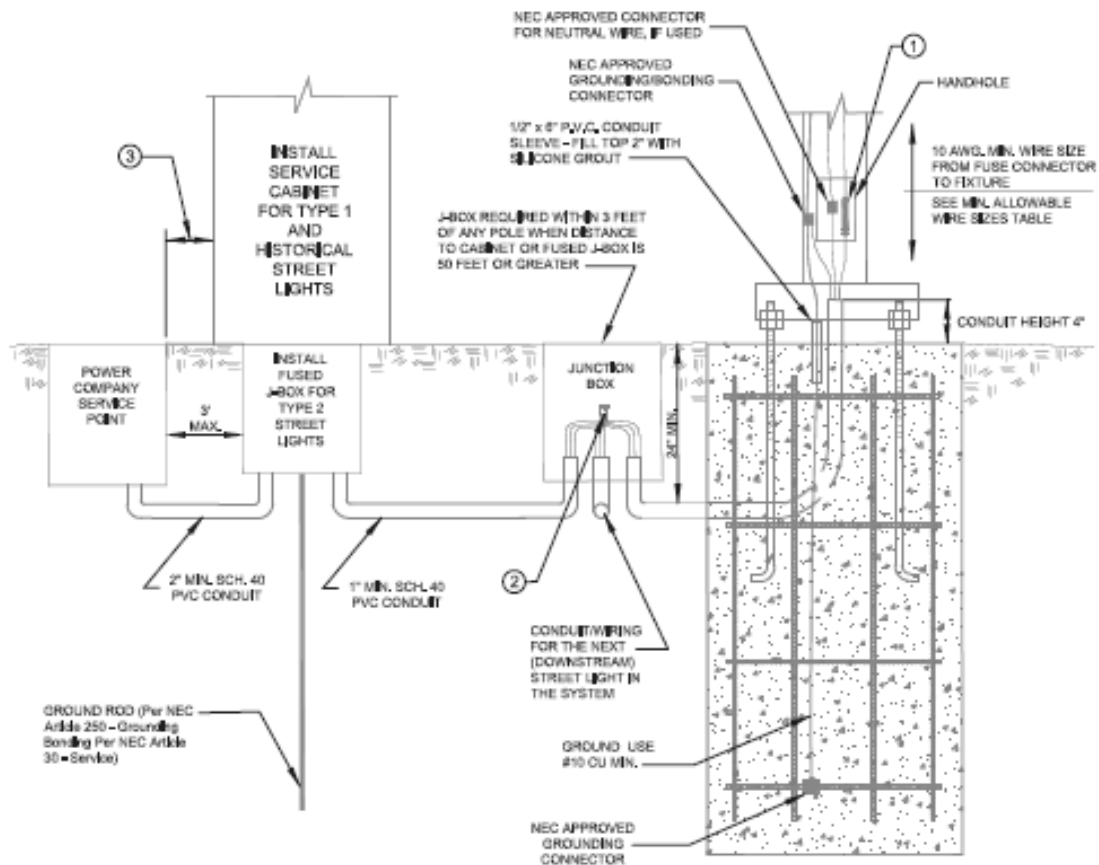

LEGEND

- ① EACH PHASE CONDUCTOR SHALL BE FUSED AT EVERY POLE AND SERVICE JUNCTION BOX BY MEANS OF IN-LINE CONNECTORS. USE ONLY FAST ACTING FUSES RATED 100K RMS AMPS, 600 VAC
- ② WHEN A SPLICE IS REQUIRED USE SEC MODEL 079-SO SPLICE KIT, POLARIS SSB 2/0, OR APPROVED EQUAL. AN 18" MINIMUM SLACK LOOP IS REQUIRED IN ALL JUNCTION BOXES
- ③ IF DISTANCE FROM POWER COMPANY SERVICE POINT TO SERVICE CABINET IS GREATER THAN 10 FEET, A FUSED J-BOX SHALL BE INSTALLED WITHIN 10 FEET OF POWER COMPANY SERVICE POINT. DISTANCE FROM POWER COMPANY SERVICE POINT TO SERVICE CABINET SHALL NOT EXCEED 150 FEET.

REVISED 2015

CITY OF MERIDIAN
SUPPLEMENTAL
SPECIFICATIONS
TO THE IDAHO STANDARDS FOR
PUBLIC WORKS CONSTRUCTION

**WIRING REQUIREMENTS FOR
STREET LIGHT INSTALLATIONS**

STANDARD DRAWING NO.

T3

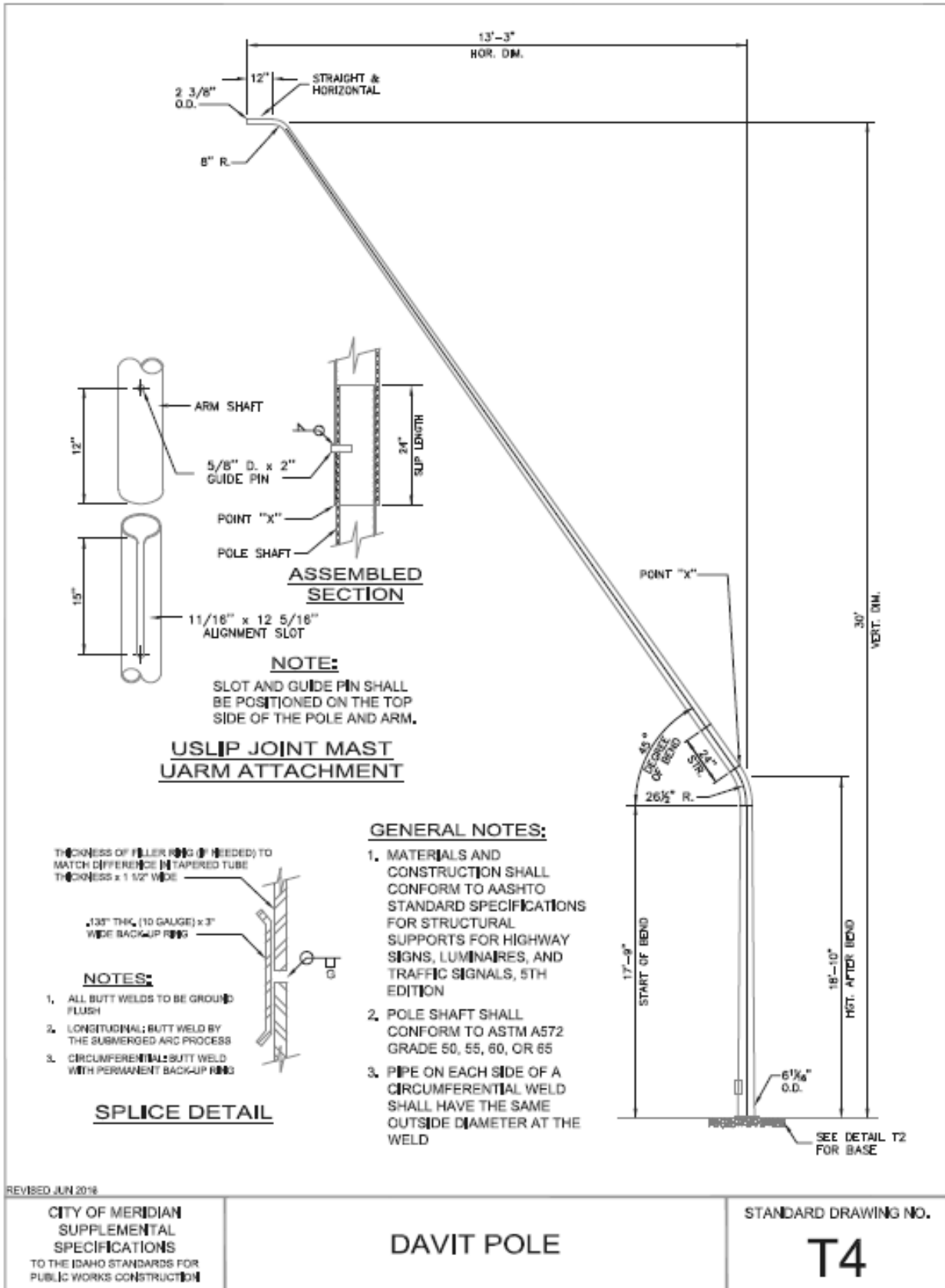

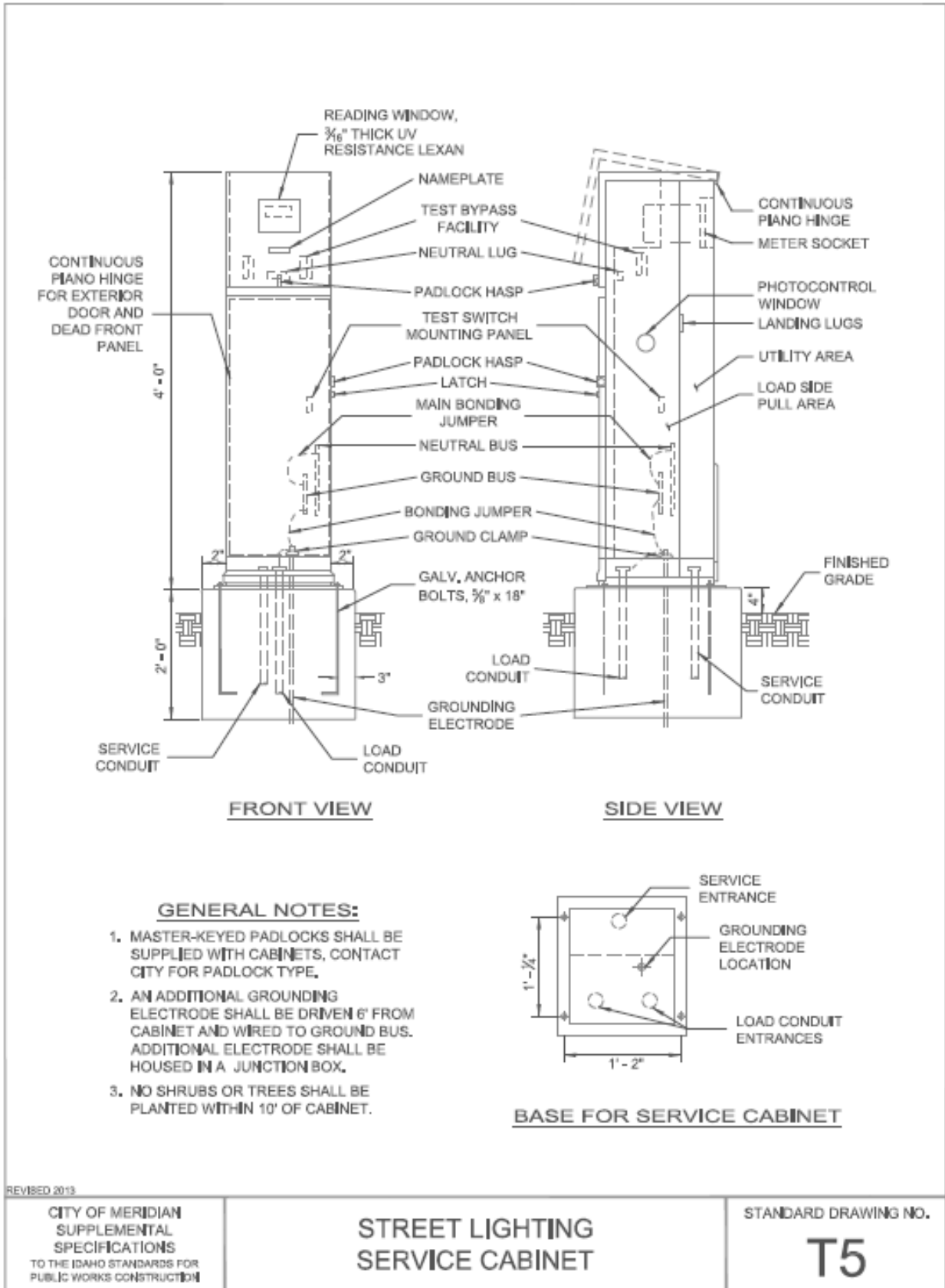

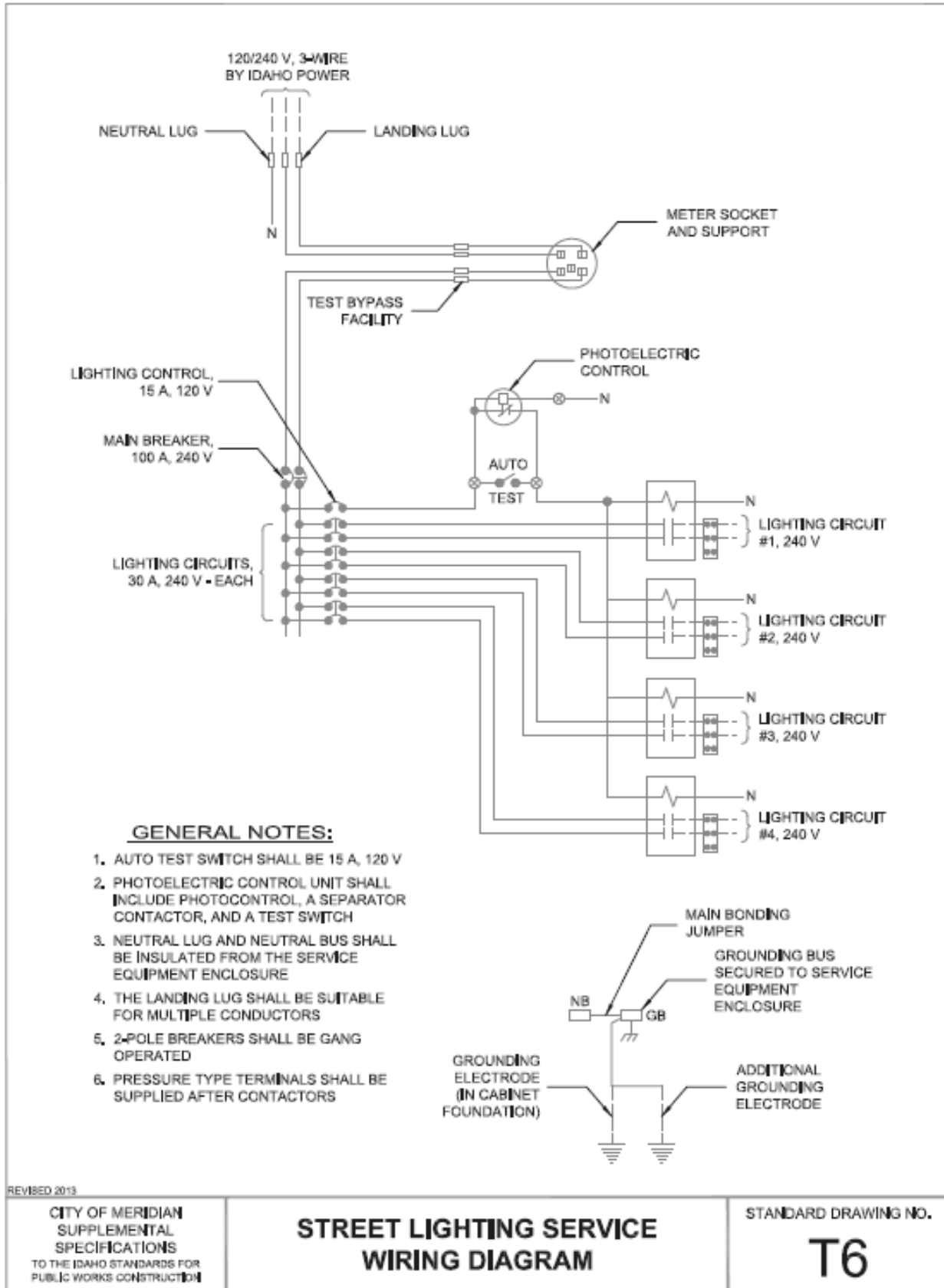

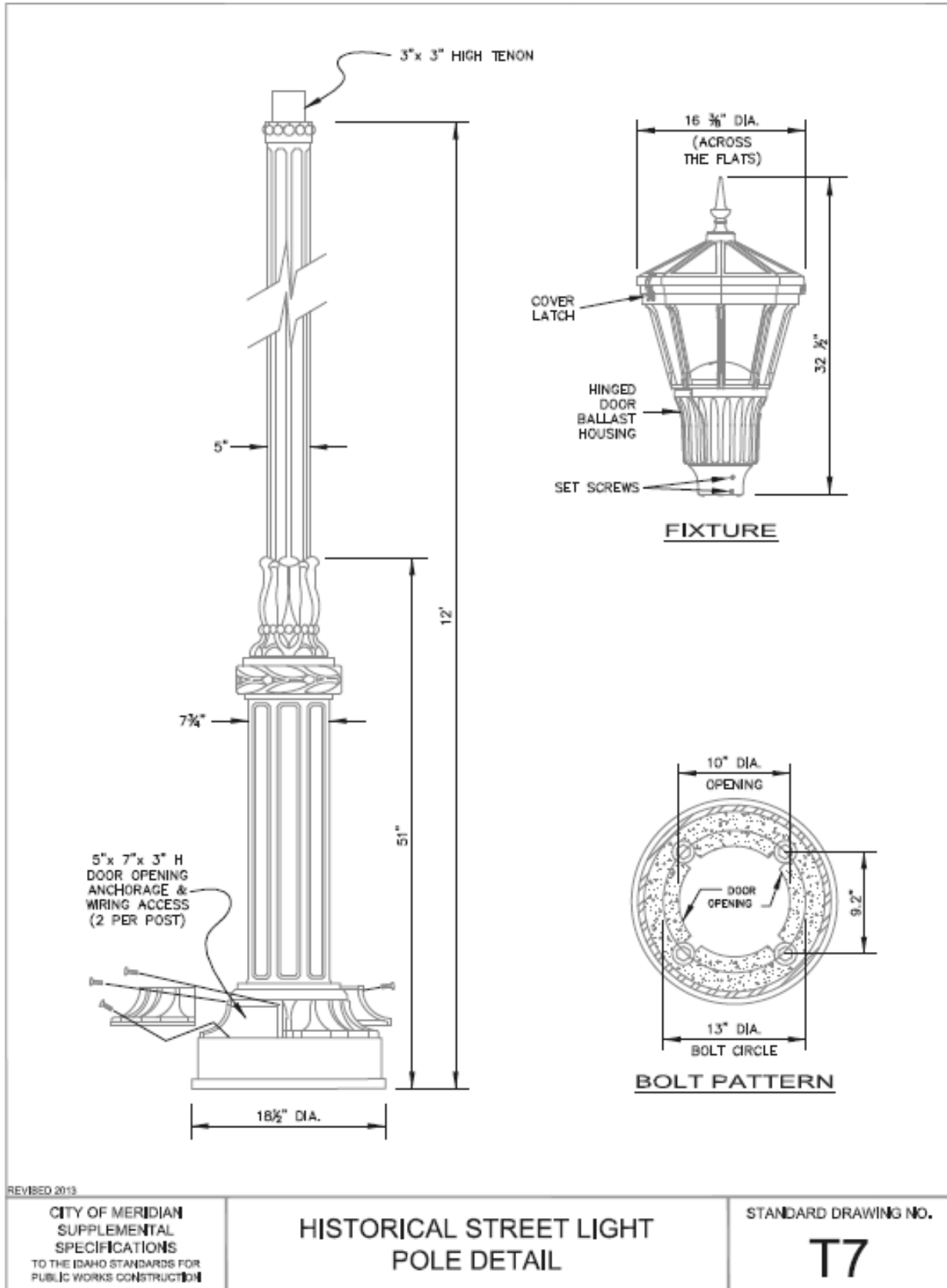

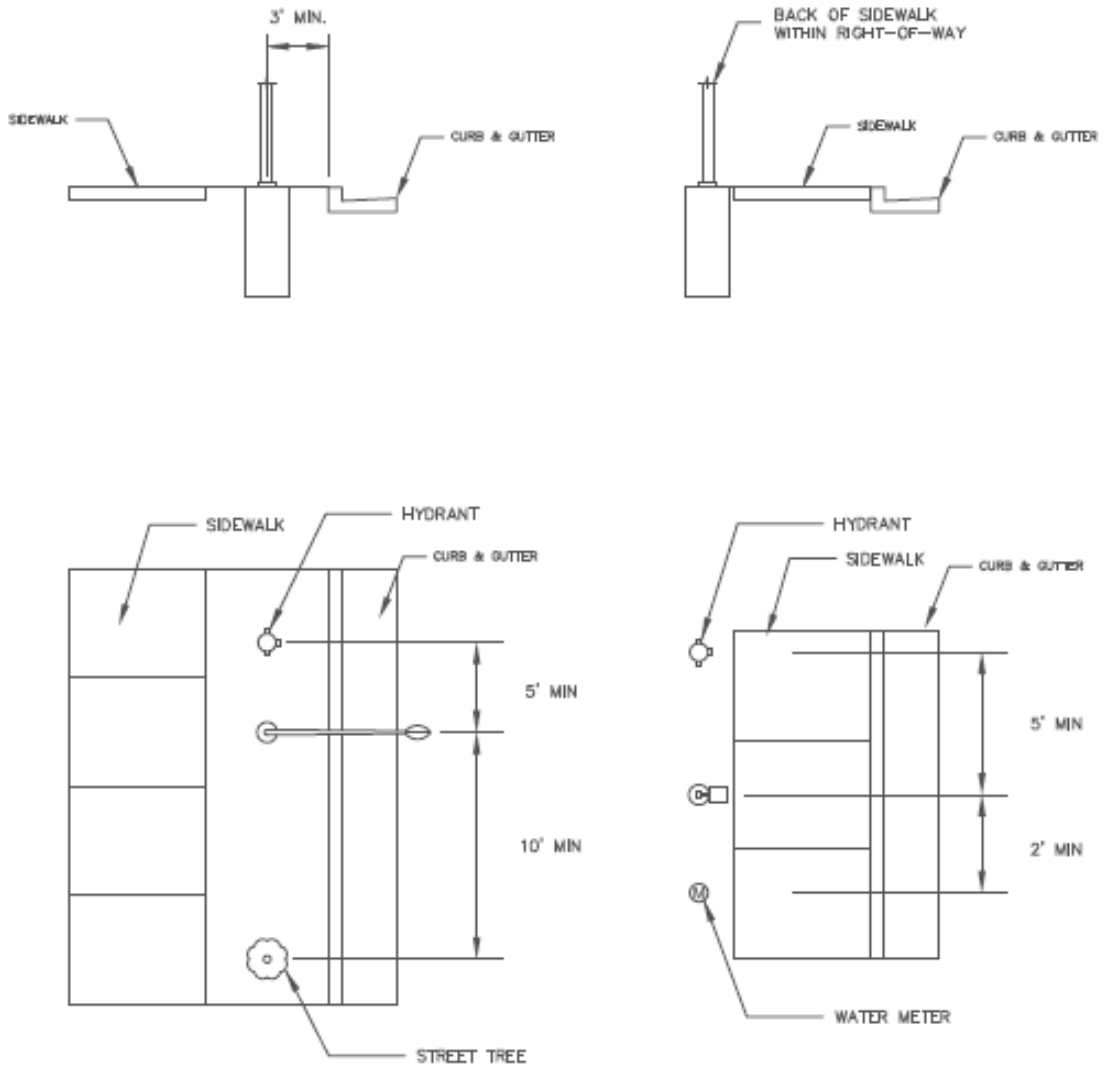

REVISED JUN 2018

CITY OF MERIDIAN
 SUPPLEMENTAL
 SPECIFICATIONS
 TO THE IDAHO STANDARDS FOR
 PUBLIC WORKS CONSTRUCTION

STREET LIGHT BASE LOCATIONS

STANDARD DRAWING NO.

T8

Appendix E – Future Install/Reimbursement Agreement

RECORDING REQUESTED BY AND

WHEN RECORDED RETURN TO:

City Clerk

City of Meridian

33 E. Broadway Avenue

Meridian, ID 83642

AGREEMENT TO ACCEPT DEPOSIT FOR INSTALLATION OF STREETLIGHTS

THIS AGREEMENT for streetlight deposit (“Agreement”), made this XX day of _____, 202X by and between the City of Meridian, a municipal corporation organized under the laws of the State of Idaho, whose address is 33 East Broadway Avenue, Meridian, Idaho, and XX., whose address is XX, Meridian, Idaho 8364X.

WHEREAS, Property Owner is the owner of XX, located at Located at the XX, Meridian, Ada County, Idaho, described as XX, City of Meridian, Ada County, Idaho;

WHEREAS, one of the site-specific conditions of approval of City’s approval of XX/Conditions of Approval with attached record drawings, attached hereto as Exhibit A, is to install XXXX (X) streetlights along XX Road on Subject Property.

WHEREAS, Unified Development Code (“UDC”) section 11-5C-3(B) authorizes Property Owner to post a performance surety for such improvements that are needed;

WHEREAS, UDC section 11-5C-3(D) authorizes sureties in the form of a cash deposit; and,

WHEREAS, under UDC section 11-5C-4, if Property Owner fails to complete the public improvements in the time period required, the City Council may proceed to have such work completed at Property Owner’s expense;

NOW THEREFORE, for good and valuable consideration, the receipt and sufficiency of which is hereby acknowledged and agreed, and in consideration of the mutual promises and covenants herein contained, and in consideration of the recitals above, which are incorporated herein, the Parties agree as follows:

I. COMMITMENTS BY PROPERTY OWNER.

- A. Deposit.** Property Owner shall pay a deposit to City in the amount of XXXX Dollars and Zero Cents (\$X,XXX.XX).

- B. Installation.** Property Owner shall obtain all necessary permits, inspections, and plan approvals for the installation of the Streetlights, and install the Streetlights, by XX
Property Owner shall comply with all applicable laws, including Meridian City Code and the City of Meridian Improvement Standards for Street Lighting.
- C. Demand for return of Deposit.** Within thirty (30) days of Property Owner’s installation of the Streetlights and completion of all necessary inspections in compliance with applicable codes, Property Owner shall provide to City a written demand for the return of the Deposit.
- D. Consent to entry.** Property Owner shall, and hereby does, provide to the City perpetual consent and access to enter the Subject Property for the purpose of inspecting or installing Streetlights and related infrastructure. Except in the event of an imminent or realized threat to the public health, safety, or welfare, City shall provide Property Owner at least twenty-four (24) hours prior notice of such entry. Such notice may be verbal, written, or be posted at the Subject Property.
- E. Additional expense for installation.** If Property Owner forfeits the Deposit due to failure to comply with this Agreement, and City installs the Streetlights, Property Owner shall be responsible for paying to City any amount exceeding the Deposit within thirty (30) days of City’s invoice therefor.

II. COMMITMENTS BY CITY.

- A. Recordation.** City shall record this Agreement, and shall submit proof of such recording to Property Owner.
- B. Hold Deposit.** City shall hold Property Owner’s Deposit until Property Owner installs Streetlights as required by this Agreement.
- C. Return of Deposit.** Within thirty (30) days of Property Owner’s installation of the Streetlights, completion of all necessary inspections in compliance with applicable codes, and City’s receipt of Property Owner’s written demand for the return of the Deposit, City shall return the Deposit to Property Owner.
- D. Default.** If Property Owner fails to install the Streetlights before the Due Date, Property Owner shall forfeit the Deposit to City, and City shall install the Streetlight at Property Owner’s sole expense.

III. GENERAL PROVISIONS.

- A. Default.** Any failure to perform the terms and conditions of this Agreement, or any

portion thereof, shall be a default hereunder.

- B. Remedies.** In the event of Property Owner’s default, in addition to other remedies specified herein, the City may withhold building, electrical, plumbing permits, certificates of zoning compliance, or certificates of occupancy for the Subject Property or improvements thereon, if Streetlights have not been installed as required.
- C. Enforcement.** This Agreement shall be enforceable in any court of competent jurisdiction by either City or Property Owner, or any respective successor(s) in interest thereof. An action at law or in equity, as appropriate, shall lie to secure specific performance of any covenant, agreement, condition, commitment, and/or obligation set forth herein. In addition, remedies available to City shall include, but shall not be limited to, a lien on the property, collections, or revocation of land use approvals and/or certificates of occupancy for buildings on the Subject Property.
- D. Notices.** Any notice desired by the Parties or required by this Agreement shall be deemed delivered after deposit in the United States Mail, postage prepaid, addressed as follows:
- | | |
|--|--------------------------------------|
| <p>If to City:
 City of Meridian
 City Clerk
 33 E. Broadway Ave.
 Meridian, Idaho 83642</p> | <p>If to Property Owner:
 XX</p> |
|--|--------------------------------------|
- Either Party may change its address for the purpose of this section by delivering to the other Party written notification of such change, establishing a new address for noticing purposes, in accordance with the requirements of this section.
- E. Time is of the essence.** The Parties acknowledge and agree that time is strictly of the essence with respect to each and every term, condition, and provision hereof, and that the failure to timely perform any of the obligations hereunder shall constitute a breach and default hereunder by the Party so failing to perform.
- F. Binding upon successors.** Except as otherwise specifically provided herein, this Agreement shall be binding upon any and all owners of the Subject Property, any and all subsequent owners thereof, and each and every other person acquiring an interest in the Subject Property. Nothing herein shall, or shall be construed to, in any way prevent the sale or alienation of the Subject Property, or any portion thereof, except that any sale or alienation shall occur subject to the provisions of this Agreement, and any successive owner or owners shall be both benefited and bound by the conditions and restrictions herein expressed.
- G. Severability.** If any provision of this Agreement is held invalid by a court of competent jurisdiction, such provision shall be deemed to be excised herefrom and the invalidity thereof shall not affect any other provision or provisions contained herein.
- H. Attorney fees.** Should any litigation be commenced between the parties hereto concerning this Agreement, the prevailing party shall be entitled, in addition to any other relief as may be granted, to court costs and reasonable attorney fees as determined by such court. This provision shall be deemed to be a separate contract between the Parties and shall survive, *inter alia*, any default, termination, or forfeiture of this Agreement.
- I. Final Agreement.** This Agreement sets forth all promises, inducements, agreements, conditions, and understandings between City and Property Owner relative to the subject matter hereof, and there are no promises, agreements, conditions, or understandings,

either oral or written, express or implied, between City and Property Owner, other than as are stated herein. Except as otherwise specifically provided herein, no subsequent alteration, amendment, change, or addition to this Agreement shall be binding upon the Parties unless set forth in writing and duly executed by both Parties or their successors in interest.

- J. Non-waiver.** Failure of either Party to promptly enforce the strict performance of any term of this Agreement shall not constitute a waiver or relinquishment of any Party’s right to thereafter enforce such term, and any right or remedy hereunder may be asserted at any time after either party becomes entitled to the benefit thereof, notwithstanding delay in enforcement. All rights and remedies herein enumerated shall be cumulative and none shall exclude any other right or remedy allowed by law. Likewise, the exercise of any remedy provided for herein or allowed by law shall not be to the exclusion of any other remedy.
- K. Compliance with laws.** Throughout the course of this Agreement, the Parties shall comply with all applicable laws, ordinances, and codes of Federal, State, and local governments. This Agreement shall be governed by and construed and enforced in accordance with the laws of the State of Idaho, and the ordinances of the City of Meridian. The City’s ordinances appertaining to streetlight installation and maintenance, and any prospective amendments to and/or recodifications thereof, are specifically and without limitation incorporated into this Agreement as if set forth fully herein.
- L. Advice of attorney.** Each party warrants and represents that in executing this Agreement, it has received independent legal advice from its attorney or the opportunity to seek such advice.
- M. Approval Required:** This Agreement shall not become effective or binding until approved by the City Council of the City of Meridian.

IN WITNESS WHEREOF, the parties shall cause this Agreement to be executed by their duly authorized officers the day and year first above written.

Property Owner:

XX

STATE OF IDAHO)
) ss:
County of _____)

I HEREBY CERTIFY that on this _____ day of _____, 202X, before the undersigned, a Notary Public in the State of Idaho, personally appeared XX, proven to me to be the person who executed the said instrument, and acknowledged to me that such person executed the same.

IN WITNESS WHEREOF, I have hereunto set my hand and affixed my official seal, the day and year in this certificate first above written.

Notary Public for Idaho

Residing at _____, Idaho

My Commission Expires: _____

CITY OF MERIDIAN:

Attest: _____

Robert E. Simison, Mayor

Chris Johnson, City Clerk

STATE OF IDAHO)
 : ss
County of Ada)

I HEREBY CERTIFY that on this _____ day of _____, 202X, before the undersigned, personally appeared ROBERT E. SIMISON and CHRIS JOHNSON, known or identified to me to be the Mayor and City Clerk, respectively, of the City of Meridian, who executed the instrument on behalf of the City of Meridian, and acknowledged to me that the City of Meridian executed the same.

IN WITNESS WHEREOF, I have hereunto set my hand and affixed my official seal the day and year in this certificate first above written.

Notary Public for Idaho

Residing at _____, Idaho

My Commission Expires: _____

Appendix F – Streetlight Underserved Areas

NOTE: Light counts are approximate

Streetlight Deficient Areas - Commercial	Lights Needed	Streetlight Deficient Areas - Residential	Lights Needed
I-84/St Lukes-West of Eagle Rd	20	Locust View Heights Sub	28
Stratford - Franklin Rd/Central	8	West of Eagle Rd-South of Franklin Rd	40
Commerce Park	5	Crossroads Sub	16
Records-East & Cemetery	6	East of Julius Kleiner Park	12
Eagle Rd-North of Ustick (Decorative)	16	Duane Drive	8
Pine-West of Ocean Ave	1	Bienville	5
Pine-Ocean to Mineral	2	Carols Sub	20
Pine-Mineral to Rotan	6	Champion Park Sub	12
Pine-Rotan to Tall Pine	2	Summerfield Subs	18
Ustick Road-Venable to Linder	2	Thousand Springs Sub	20
Venable Ave (Type II)	15	Kentucky Ridge Sub	4
Ustick Road-Linder to Ten Mile	8	Meridian Heights Sub	7
Ustick Road-Ten Mile to Black Cat	1	Stoddard Rd - Overland/Victory	4
Franklin Road-Truckee to Eagle Rd	9	Ten Mile Crossing Offsite Sub	25
Amity-Boise Border to Eagle Road	9	Castlebrook Sub	15
Amity-Eagle Road to Locust Grove	20	Rods Parkside Sub	28
Amity-Locust Grove to Meridian Road	20	Blackstone Sub	6
Victory-City Limits to Eagle Road	16	Milliron Place Sub	8
Victory-Eagle Road to Locust Grove	18	Golf View Estates Sub	22
Victory-Locust Grove to Meridian Road	8	Cherry Lane Village Sub	105
Victory-Meridian Road to Linder	30	Lake at Cherry Lane Sub	22
Franklin Road-City Limits to Eagle Road	24	Turnberry Sub	13
Franklin Road-Eagle to Locust Grove	35	Tricias Sub	12
Franklin Road-Locust Grove to Main St	27	Wilkins Ranch Sub	8
Franklin Road-Linder to Ten Mile	26	Dakota Ridge Sub	8
Fairview-City Limits to Eagle Road	23	Candlelight Sub	16
Fairview-Eagle Road to Locust Grove	25	Parkwood Meadows Sub	6
Ustick-City Limits to Locust Grove	21	Tuthill Estates Sub	9
Ustick-Locust Grove to Meridian Road	27	Kentfield Manor Sub	7
McMillan-City Limits to Locust Grove	15	Fieldstone Meadows Sub	31
McMillan-Locust Grove to Meridian Rd	27	Tumble Creek Sub	12
McMillan-Meridian Road to Linder	21	Turtle Creek Sub	18
McMillan-Linder to Ten Mile	21	Glennfield Manor Sub	34
Cherry Lane-Linder to Black Cat	25	One Sub	15
Overland Road-City Limits to Ten Mile	18	Valeri Place Sub	5
Pine-Tall Pine to Linder	18	Cherry Crossing Sub	3
Pine-NW 15th to NW 11th	17	Vineyard Sub	34

STREETLIGHT MASTER PLAN

Streetlight Deficient Areas - Commercial	Lights Needed	Streetlight Deficient Areas - Residential	Lights Needed
Pine-NW 8th to NW 4th	20	Tiburon Sub	5
Pine-NW 1st to Meridian	50	Haven Cove Sub	50
Fairview-Locust Grove to Meridian Road	50	Thunder Creek Sub	2
		Sommersby Cove Sub	3
		Sommersby Sub	7
		Lyndhurst Grove Sub	3
		Courtyards at Ten Mile Sub	4
		Canterbury Commons Sub	10
		Morning Glory Sub	10
		Merrywood Sub	15
		Conifer Sub	4
		Hunter Estates Sub	2
		Ryan Place Sub	2
		Dunten Place Sub	3
		Meridian Manor Sub	8
		Waterbury Sub	1
		Fothegill Pointe Sub	4
		Parkway Sub	4
		Southwick Sub	4
		Meridian Park Sub	3
		Sheri Lynn Sub	4
		Sienna Creek Sub	6
		Baldwin Park Sub	2
		Cedar Springs Sub	7
		Watersong Estates Sub	9
		Ambercreek Sub	7
		Cedarcreek Sub	11
		Fulfer Sub	3
		Verona Sub	9
		Brody Square Sub	4
		Observation Point Sub	2
		Mesa Way (Residential Road)	2
		Meridian Greens Sub	1
		Country Terrace Sub	3
		Larkspur Sub	2
		Elk Run Sub	4
		Lanark/Guadian Ave (Type II Road)	12
		Unnamed Sub North of Locust Elem.	4
		Zebulon Heights Sub (Decorative)	11

STREETLIGHT MASTER PLAN

Streetlight Deficient Areas - Commercial	Lights Needed	Streetlight Deficient Areas - Residential	Lights Needed
		Edinburgh Place Sub	5
		Sheridan Place Sub	1
		Vienna Woods Sub	4
		Unnamed Sub (Amble Run Sub)	3
		Unnamed Sub (Shandee Drive)	1
		Hollybrook Sub	7
		Rowan Add Sub	8
		Bowers Add Sub	12
		Noe Valley Sub	4
		School Crossroads Middle	3
		Locust Grove Industrial	2
		Olson and Bush	7
		Unnamed Sub by Keylock Storage	5
		Meridian Commercial Sub	11
		Unnamed Sub East of Knightbridge Sub	6
		Unnamed Sub (Dartmoor Drive)	7
		Nurses Add Sub	10
		CDBG Eligible	
		Weathervane Village Sub	44
		Westlawn Estates Sub	7
		Tremont Place Sub	5
		Gem Estates Sub	7
		Seabury Sub	7
		Idaho St Res Sub	36
		Herby Sub	10
		Westview Add to Meridian Sub	12
		Anderson J.M. Home Plat Sub	8
		Leisman Add Sub	3
		Piedmont Sub	8
		Navaro Place Sub	7
		Canna Lily Estates Sub	11
		Applegate Sub	12
		Unnamed Sub North of Navaro Sub	2
		Gregory Sub	5
		Welker Sub	12
		Frost Add to Meridian Sub	14
		Nidays Add to Meridian Sub	2
		Fran Meridian Sub	2
		Western Sub	2

STREETLIGHT MASTER PLAN

Streetlight Deficient Areas - Commercial	Lights Needed	Streetlight Deficient Areas - Residential	Lights Needed
		Town J.L. Sub	5
		Wilson Sub	6
		Doris Sub	9
		Settlers Village	6
		Devon Park Sub	4
		Danbury Fair Sub	3
		Meridian Business Park Sub	4
		Taylor Sub	5
		Terra Sub	2
		Gem States Sub	27
		Fairview Mixed I Sub	12
		Promenade Cottages Sub	40
		Fairview Mixed II Sub	6
		Cottage Home Add Sub	4

Appendix G – Customer Service and Customer Complaints Process

Outage Procedures/Complaint Processes

In order to maintain a standard of customer service, the City has developed an online, user friendly data network for customers to report outages and complaints. This system also allows the City to maintain the proper asset data needed to track these outages and complaints.

Outages/Customer Calls/Complaints

The City receives a number of streetlight outages and complaints reported each month.

- ~50 outage reports monthly
 - ~7 false reports each month
- ~8 complaint/issue calls monthly

The current geodatabase has many inaccuracies and missing data which makes the current process of addressing outages time consuming for multiple staff members. It takes several staff members to search for relevant data in multiple locations for every streetlight reported. The current process is as follows:

- Find the location on the streetlight map
- Check the streetlight attributes for ownership and warranty information (if available)
- Research historical data to verify ownership and warranty information
- Check Microsoft Access database to verify the streetlight has not already been sent to the maintenance contractor for repair
- Warranty/repair status verification:
 - If there is not a recent work order, check to see if the streetlight is covered by a warranty.
 - If it is not covered by a warranty:
 - Create/Save a new work order in Access.
 - Save a copy of the work order in the S:/Outages folder
 - Enter outage information into the Work Orders Pending spreadsheet for tracking
 - Email a copy of the outage report and work order:
 - If Idaho Power-Owned Light: Send to Idaho Power
 - If City-Owned Light: Send to maintenance contractor
 - Once repair is confirmed by contractor, process invoice when received
 - Update streetlight status in Access database/close work order
 - Update new warranty date in GIS
 - If the work or fixture is covered under warranty:
 - Research developer/contractor/supplier information to contact
 - Create/Save work order in Access
 - Save a copy of the work order in the S:/Outages folder
 - Enter outage information into the Work Orders Pending spreadsheet for tracking
 - Email a copy of the outage report and work order with the warranty information to the original contractor of record

- Verify that the streetlight has been repaired
- Update streetlight status in Access database/close work order
- Update new warranty date in GIS
- If the streetlight was previously assigned:
 - Email a follow-up request notification to maintenance contractor
 - Update notes in Access, on the work order in the Outage Report file, and update the Orders Pending spreadsheet
 - Once repair is confirmed by contractor, process invoice when received
 - Update streetlight status in Access database/close work order
 - Update new warranty date in GIS

NOTE: Boise averaged around 50 streetlight outage reports per month prior to fully upgrading their streetlights to LED. After the upgrade was complete, Boise now averages two (2) outage reports per month.

Damage Claim Process

Damage claims are random occurrences, the most common being cars hitting a streetlight pole. There are also other incidents which cause damage (weather, vandalism, etc.). When damage claims come in, there are numerous steps depending on the extent and type of damage.

If there's a streetlight that is damaged, the following steps are required:

- If the streetlight has fallen over or has the potential to fall, have the maintenance contractor secure the streetlight
- Determine if there is a liable party for the damage
- Fill out a Damage Claim (request a police report if applicable)
- Request an estimate for repairs by the City's electrical contractor
- Send the Damage Claim and estimate to the Legal Department (Legal will handle all necessary ICRMP paperwork)
- Request a repair from maintenance contractor
- TUC or qualified inspector will verify repairs were completed
- Process repair invoice after repair
- Send a copy of the repair invoice to Legal for ICRMP closing
- Close out damage claim - Update streetlight status in Access database/close work order
- Update new warranty information in GIS

Shielding

Current Standards

The City has current streetlights standards that address streetlight shielding and pole spacing requirements. It is generally not necessary for the City to install shields on all lights.

From time to time, the Department receives complaints related to nuisance light from streetlights. The majority of complaints relate to changes in streetlights that take place as new development occurs.

Each complaint should be treated and analyzed as unique due to various factors. In some instances, a shield may be a viable option to deal with valid lighting complaints.

There are financial impacts to shielding lights as well as some potential drawbacks which can include sidewalks not being illuminated appropriately thereby raising safety concerns. Adding shields to new LED lights before they are installed costs approximately \$50/light. Adding a shield after installation generally costs \$250/light.

Public Works does not recommend shielding lights where there is not a valid light nuisance issue.

Complaint Process

Each complaint is analyzed using light metering technology. Illumination thresholds and guidelines are established in the AASHTO Roadway Lighting Design Guide. In the event light trespass exceeds levels identified in the Guide, a shield may be warranted.

In order to analyze the light trespass, the Transportation and Utility Coordinator takes a light meter reading in the dark hours of the night. The currently acceptable light meter reading for the City is anything 2 Lux or lower taken at the nearest property boundary between the streetlight and the residence of complaint. Readings at this level are considered an acceptable amount of light trespass and do not warrant the City paying for a light shield. If the reading is 2 lux or lower at the property line, it will be substantially lower at the actual residence.

Occasionally, the City of Meridian receives a request to install a light shield on a light that does not exceed the 2 lux light trespass criteria. If pedestrian or vehicular safety is not compromised, the City has allowed the installation of the light shield if the citizen is willing to pay for the cost to install the shield. In these cases, the City enters into an agreement with the citizen to document the terms by which the light shield can be paid for and installed.

Appendix H – Annual Report Information

Starting in 2022, an annual streetlight progress report will be developed and included as an attachment to this to document system statistics, major projects completed, major milestones completed, costs, and budget forecasts.

Streetlight Annual Report	
Year: FY2022	Date Completed: 12/30/22 By: Laurelei McVey & Micah Bandurraga
System Statistics	
Total Number of Streetlights	9,643
Total Number of City Owned Streetlights	8,178
Total Number of Other Party Owned Streetlights	1,465
Total Number of LEDs	4,322
City Owned LEDs	4,151
Other Owned LEDs	151
100W Bulbs	1,199
50W Bulbs	2,572
Total Number of HPS	5,136
City Owned HPS	4,027
Other Owned HPS	1,109
250W Bulbs	263
100W Bulbs	3,516
Number of Lights on ID Power Poles	476
Number of Direct Bury Poles	Unknown
New Additions - 2022	
Number of City Added Lights (Underserved, CDBG, and Reimbursement Agreements)	104
Number of Developer Added Lights	385
Major Projects Completed in 2022	<ul style="list-style-type: none"> ▪ New streetlights were added along Locust Grove between Pine and Fairview for optimization of the corridor. ▪ New streetlights and LED upgrades were done around Chief Joseph Middle School. This area has had a history of above average crime in the surrounding subdivisions.

STREETLIGHT MASTER PLAN

LED Upgrades	
Number of 100W HPS Lights Upgraded	360
Number of 250W HPS Lights Upgraded	0
Underserved Areas	
Total Needed Underserved Area Lights	1,702
Type II Lights	999
Type I Lights	703
CBDG Eligible Lights	179
Budgets/Costs	
Cost to Install:	
New Type I Light	\$14,500
Davit Pole	\$16,500
New Type II Light	\$9,500
Consultant Design per Light	\$1,500
Upgrade to LED (Type I)	\$560
Upgrade to LED (Type II)	\$480
HPS Bulb Replacement - 100W	\$110
HPS Bulb Replacement - 250W	\$215
Budgets:	
FY22 Electrical/Power	\$1,276,818
FY22 Repair & Maintenance	\$75,000
FY22 LED Conversions	\$375,000 + \$138,704 CF
FY22 Underserved Areas (GF)	\$79,750
FY22 Underserved Areas (CBDG)	\$144,863 + \$112,149 CF
FY22 Idaho Power Incentives Received	TBD
Notes: Wattage for 380 LED lights missing in GIS, Wattage for 248 HPS missing in GIS CF=Carry Forward GF=General Fund	

*NOTE: Some data inaccuracies exist in the City’s streetlight tracking database/GIS. As such, some numbers throughout the report are estimates. Cleaning up and integrating this data into the City’s asset management system is a planned program goal.

Project Type	New Budget	Carry Forward From Previous FY	Total Budget	Committed	Spent	Remaining	# Lights Completed	Estimated Carry Forward
New Lights FY22	\$ 79,750.00	\$ (31,848.26)	\$ 47,901.74		\$ 33,298.00	\$ 14,603.74	38	\$ 14,603.74
Other Projects FY22	\$ 238,950.00	\$ 245,224.00	\$ 484,174.00		\$ 245,224.00	\$ 238,950.00	29	\$ 238,950.00
CDBG FY22	\$ 144,863.00	\$ 112,149.00	\$ 257,012.00		\$ 184,546.00	\$ 72,466.00	37	\$ 72,467.00
LED Conversion FY22	\$ 375,000.00	\$ 138,704.00	\$ 513,704.00		\$ 116,117.00	\$ 397,587.00	360	\$ 397,587.00

ACHD Cost share agreement. This was our portion of the required funds.
 Phase 2 of Winco (\$220,000) / Linder Dvlpmnt Project (\$18,950)

Idaho Power incentive funds received from FY21 to date: \$33,889.65